

Hisense



FIFA WORLD CUP  
Qatar 2022

OFFICIAL AIR CONDITIONER



# EUROPEAN

Air Conditioner  
2022-2023



A man and a woman are shown in a close embrace, smiling warmly at each other. The woman is leaning her head against the man's shoulder. They are both wearing white t-shirts. In the background, a white Hisense air conditioner is mounted on the wall. The scene is set in a modern, brightly lit living room.

# Our Mission

is to deliver an enhanced customer experience that exceeds expectations with every product we sell.

From our product's cutting-edge technology, superior performance, elegant & sophisticated design, and enduring reliability to the most trusted retail partners in the industry, nothing is ever compromised.

Step off the beaten path, choose Hisense, where innovation meets value.



<b>01</b>	<b>About us</b>		
<b>02</b>	<b>Residential Air Conditioner</b>	<b>04-07</b>	<b>04</b>
	<b>Line up</b>		<b>Light commercial</b>
	<b>Features</b>		
	<b>Products</b>		
	Silentium Pro	10-11	76-105
	Fresh Master	12-25	Features
	Energy Pro Plus	26-57	78-87
	Energy Pro	26-27	Line up
	Energy SE	28-29	88-89
	Apple Pie Pro	30-31	Products
	New Comfort	32-33	90-105
	Wings Pro	34-35	Compact Cassette
	Expert Smart	36-37	90-91
	Easy Smart	38-39	4-Way Cassette
	Wings	40-41	92-93
	Mini Apple Pie	42-43	Slim Duct
	Eco Smart	44-45	94-95
	V Pie	46-47	MSP Duct
	Portable	48-49	96-97
	<b>Technical specifications</b>	50-51	Ceiling & Floor
		52-53	98-99
		54-57	Console
		58-59	100-101
			Floor Standing
			102-105
<b>03</b>	<b>Multi-split/Freematch</b>	<b>08-59</b>	<b>05</b>
	<b>Features</b>		<b>Control System &amp; Accessories</b>
	<b>Line up</b>		
	<b>Products</b>		
	Freematch ODU	60-75	106-113
	RAC IDU	62-63	
	Cassette IDU	64-65	
	Duct IDU	66-72	
	Ceiling & Floor IDU; Console IDU	66	
	<b>Installation Drawings</b>	67-69	
		70	
		71	
		72	
		73-75	



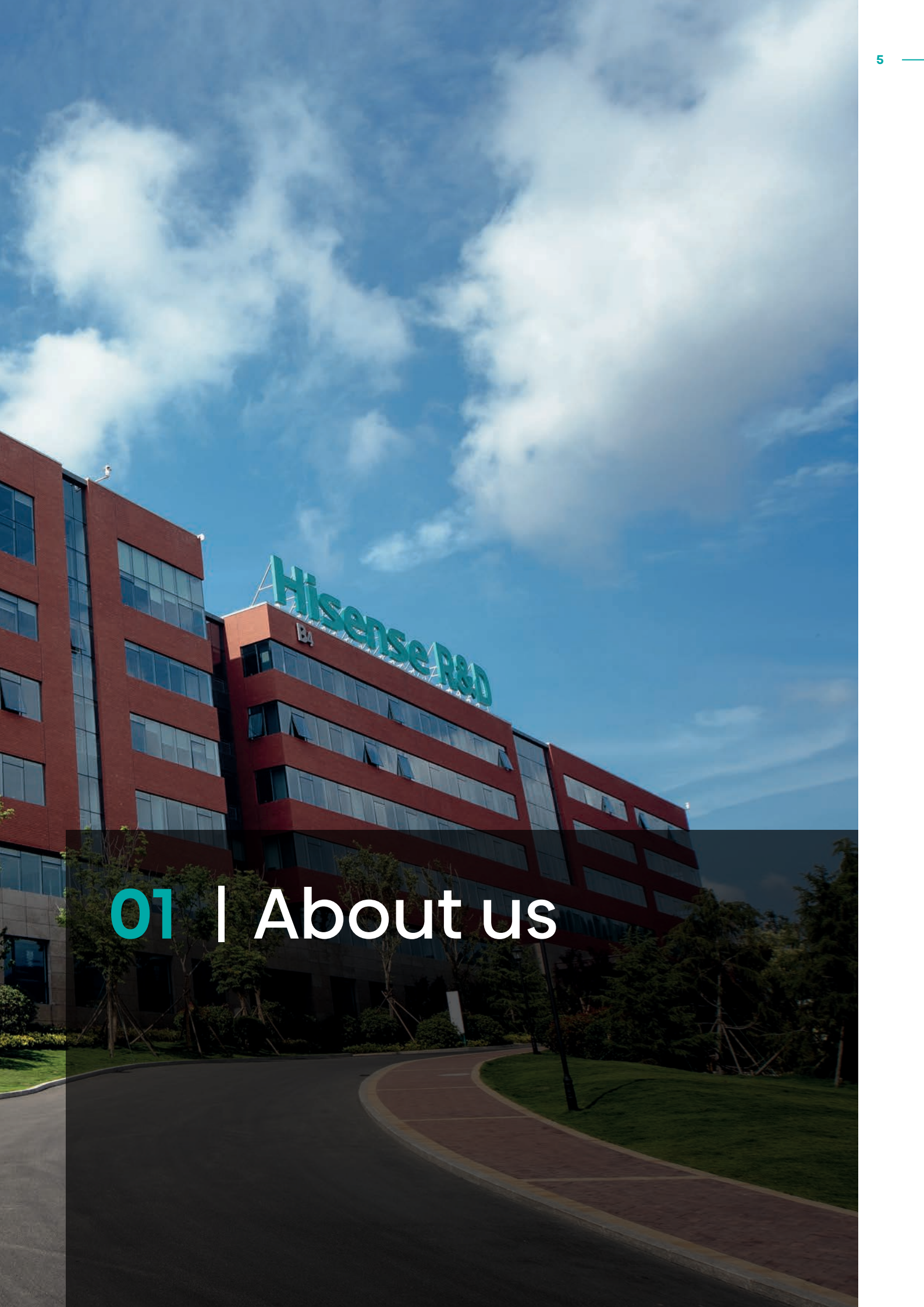

# 01 | About us

# Trusted by millions all over the world



Hisense was founded in 1969. At present, Hisense owns two listed companies - Hisense Visual Technology Co., Ltd. (600060) and HISENSE HA. (SZ000921, HK00921), listed in Shanghai, Shenzhen and Hong Kong. And it also owns many

brands including Hisense, Toshiba, Gorenje, ASKO, Kelon and Ronshen. In 2020, the overseas revenue gained 6.4 billion USD. In 2021, it achieved 11.3 billion USD, with a year-on-year growth of 43%

## Global network

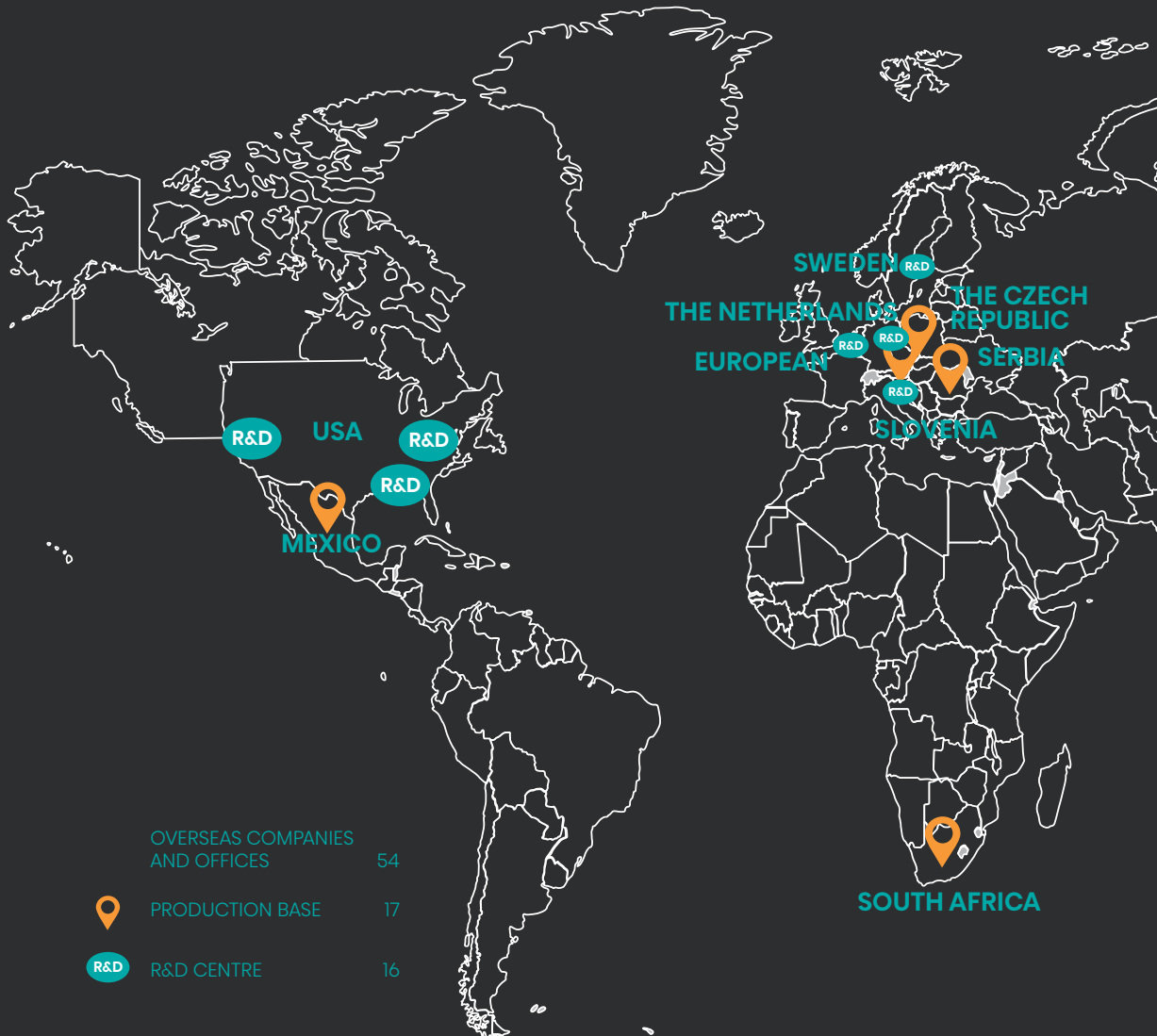

With the products exported to over 160 countries and regions, Hisense has sponsored the world's top sporting events such as UEFA EURO 2016 and 2020, and 2018 and 2022 FIFA World Cup. In the China National Image Global Survey released by China International Publishing Group, Hisense was one of the "Top Ten most

familiar Chinese brands to overseas citizens" for five consecutive years. What's more, Hisense is the first batch of innovative enterprises in China and has won the "National Quality Award" twice. Hisense Group has 14 industrial parks, which are located in Qingdao, Shunde, Huzhou, Czech Republic, South Africa, Mexico and

so on. There are also 17 R&D centers located in Qingdao, Shenzhen, USA, Germany, etc. The number of R&D personnel reached 7000 with more than 3000 Master's degree and more than 100 PhD, with which Hisense initially established a global collaborative R&D system.









## 02 | Residential Air Conditioner

# Line up

## Inverter

### Silentium Pro



2600 W  
QD25XU0EG  
QD25XU0EW

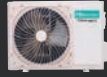

3500 W  
QD35XU0EG  
QD35XU0EW

### Fresh Master



2500 W  
QF25XW0EG  
QF25XW0EW



3500 W  
QF35XW0EG  
QF35XW0EW

### Energy Pro Plus



2600 W  
QG25XV0EG  
QG25XV0EW



3500 W  
QG35XV0EG  
QG35XV0EW

### Energy Pro

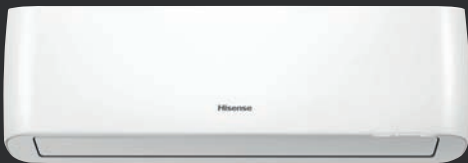

2600 W  
QE25XV0EG  
QE25XV0EW



3500 W  
QE35XV0EG  
QE35XV0EW

### Energy SE

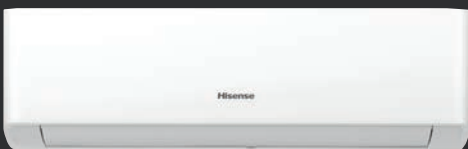

2600 W  
KA25MR0EG  
KA25MR0EW



3500 W  
KA35XR0EG  
KA35XR0EW



5000 W  
KA50BS0EG  
KA50BS0EW



7000 W  
KA70KT0EG  
KA70KT0EW

### Apple Pie Pro

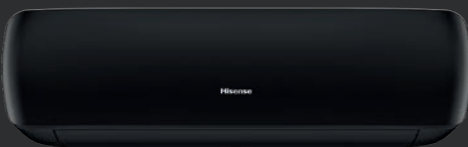

2600 W  
TG25VE0EG  
TG25VE0EW



3500 W  
TG35VE0EG  
TG35VE0EW



5000 W  
TG50XA0EG  
TG50XA0EW

### New Comfort



2600 W  
DJ25VE0BG  
DJ25VE0BW



3500 W  
DJ35VE0BG  
DJ35VE0BW



5000 W  
DJ50XA0BG  
DJ50XA0BW



7000 W  
DJ70BB0CG  
DJ70BB0CW

Wings Pro

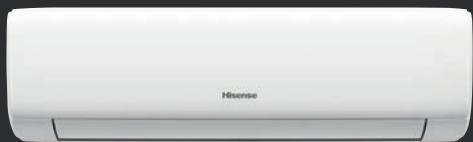

2600 W  
KB25YR3EG  
KB25YR3EW



3400 W  
KB35YR3EG  
KB35YR3EW



5000 W  
KB50XS1EG  
KB50XS1EW



6500 W  
KB70BT1EG  
KB70BT1EW

Expert Smart



2600 W  
CF25YR1FG  
CF25YR1FW



3400 W  
CF35YR1FG  
CF35YR1FW



5000 W  
CF50XS1FG  
CF50XS1FW



6500 W  
CF70BT1FG  
CF70BT1FW

Easy Smart

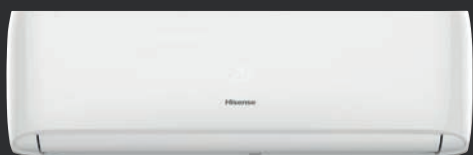

2600 W  
CA25YR03G  
CA25YR03W



3400 W  
CA35YR03G  
CA35YR03W



5000 W  
CA50XS1AG  
CA50XS1AW



6500 W  
CA70BT1AG  
CA70BT1AW

Wings

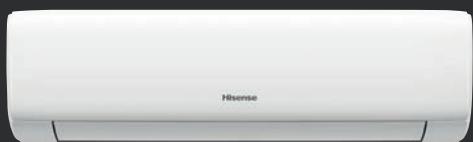

2600 W  
KB25YR3FG  
KB25YR3FW



3400 W  
KB35YR3FG  
KB35YR3FW



5000 W  
KB50XS1FG  
KB50XS1FW



6500 W  
KB70BT1FG  
KB70BT1FW

Mini apple pie



2600 W  
TG25VE0AG  
TG25VE0AW



3500 W  
TG35VE0AG  
TG35VE0AW



5000 W  
TG50XA0AG  
TG50XA0AW



7000 W  
TG70BB0BG  
TG70BB0BW

Eco Smart

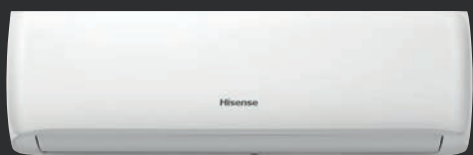

2600 W  
CD25YR3FG  
CD25YR3FW



3400 W  
CD35YR3FG  
CD35YR3FW



5000 W  
CD50XS1FG  
CD50XS1FW



6500 W  
CD70BT1FG  
CD70BT1FW

V Pie

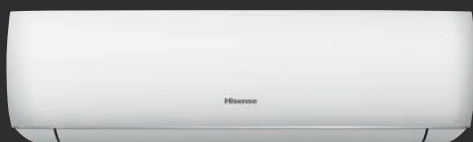

2100 W  
TV20YD1G  
TV20YD1W



2700 W  
TV25YD1G  
TV25YD1W



3600 W  
TV35VD1G  
TV35VD1W



5100 W  
TV50MA1G  
TV50MA1W

Portable



J series

2600 W APC09  
3000 W APH09  
3500 W APC12  
APH12



V series

2050 W VAPC07  
2490 W VAPC09

# Technology

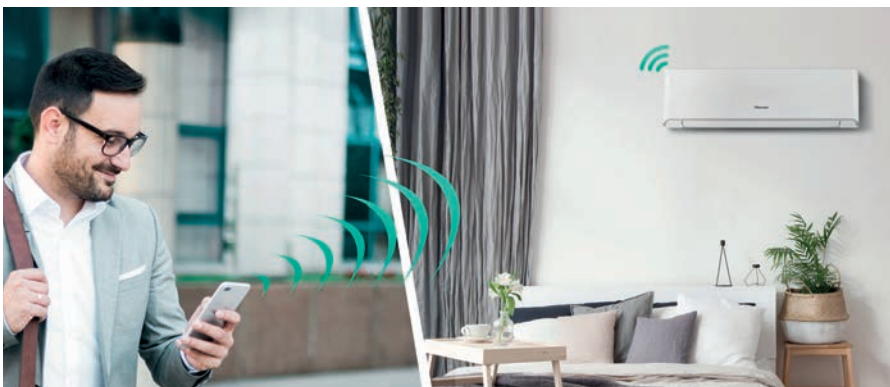

## Simple and reliable Wi-Fi operation

### Wi-Fi control

Control your air conditioner anytime and anywhere conveniently – inside and outside your home using just your Android or iOS device. Simply ensure a comfortable living environment at home at all times.

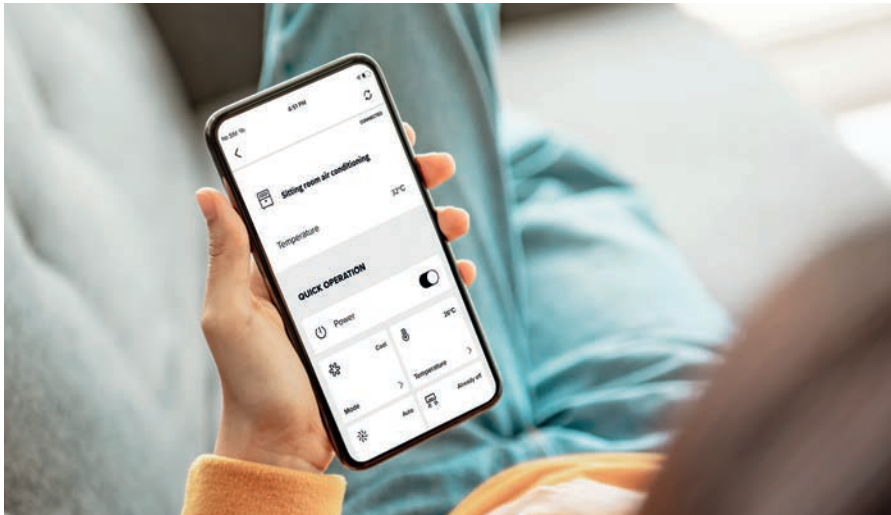

## Intelligent control from anywhere and anytime

### ConnectLife APP

Monitor and manage your air conditioner conveniently and easy anytime from anywhere. You can get the status information of your air conditioner, check the temperature and humidity in the room, update cycles for your smart air conditioning or activate intelligent functions and more. The application is available in Google Play and App Store.

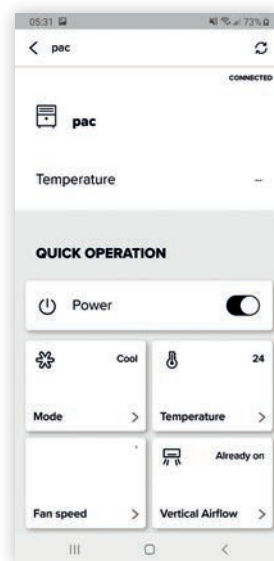
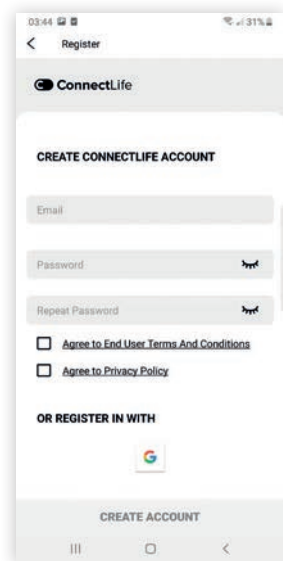
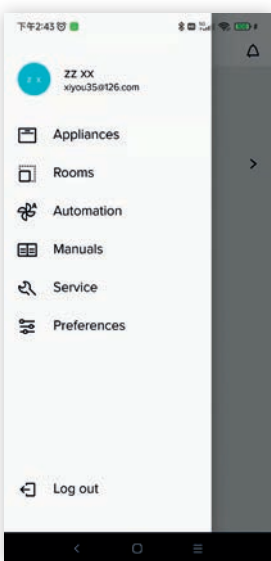

## Master your life

### Smart voice control

The new ConnectLife APP is compatible with Google virtual assistant or Amazon Alexa to lead the smart life. Thanks to voice interaction, it is possible to switch on, off and regulate the temperature, as well as setting the operating mode (cooling or heating).



## High-end technology for best performance

### Full DC inverter

360°DC inverter technology is a collection of high-end technology, which realizes intelligent operation of air conditioner and minimizes energy loss. The compressor runs more efficiently and smoothly, the temperature control is more precise, and the noise lower.

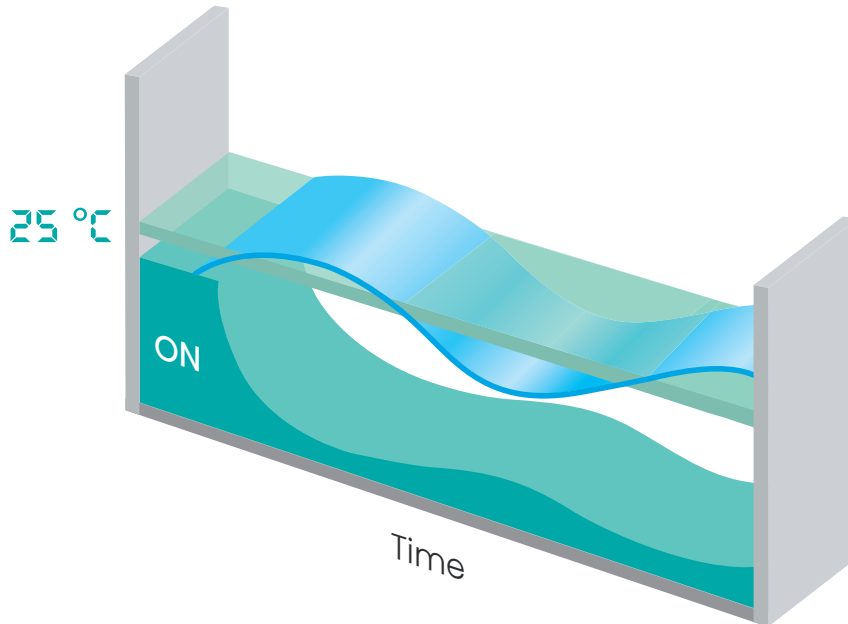

## Improving the efficiency in winter

### Outdoor unit chassis heater

Special outdoor chassis heater improves the defrosting efficiency of the chassis in winters and therefore helps to maintain your air conditioner's optimum heating performance throughout the entire season.



## Automatic protection

### Self-diagnosis protection

In case of failure, the error code is clearly displayed and easy to repair. In case of system overload, the emergency power off is initiated automatically to ensure safety.



## Two ways to suit your needs

### Dual drainage

Drainage, electrical and gas connection from either the left or the right side allows easier installation. It is easy to install, and you can choose from left or right to best suit your needs.



## Saving the energy

### 1 W standby

In standby mode, the air conditioning device automatically starts the energy saving mode. Instead of 5 W, only 1 W per hour is used, which means 80 % energy savings.



## Turbo mode

### Fast cooling

The turbo frequency increase technology enables rapid cooling or heating and allows you to enjoy larger airflow, so to feel comfortable in a shorter time.

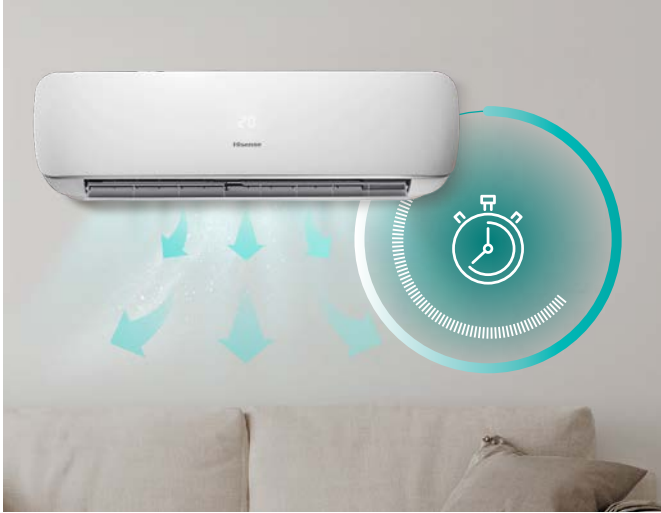

## Saving time with easiness

### Easy maintenance

With the new indoor machine structure, you have no need to move evaporator when disassembling indoor electromechanical machine. Maintenance and efficiency are thus much improved.



## Convenience assured

### Easy installation

Gas and liquid pipes can be connected when AC hang on the wall with unique easy installation structure, which is convenient and efficient. Easy installation improves installation efficiency up to 35%.



## 7 protection levels for the longevity

### Multi anti-corrosion protection

The exterior housing is protected by hot-dip galvanized steel plate and ceramic baking paint. By double zinc layer, double zinc-iron soluble layer, steel matrix, powder curing layer, ceramic paint layer they form a strong seven-fold protection and greatly extend the service life of outdoor machines.





# Wellbeing



## Purifying the air & benefiting your vitality

### Ionizer

The air conditioning device is distinguished by the super ionizer which releases important and beneficial negative ions into the air. These ions are necessary for cell metabolism and other vital functions. The efficient filtration system removes pollen, smells, smoke and dust particles, always ensuring pure and clean air.

## Keeping efficiency high and air clean

### Dual self-cleaning

Hisense's patented second generation cleaning technology takes care of indoor and outdoor unit's maximum performance. Purification process via frosting and defrosting cycle and high-temperature drying remove dust, bacteria and oil from the units effectively and easily to keep the air conditioner clean and safe.



## Eliminates the bacteria and brings you fresher air

### Hydrophilic and anti-virus aluminum fin

Special painting formula on the evaporator, highly enhance the function of antibacterial and dust clearance.



## Clear air delivery system

### Cold plasma generator

Cold plasma technology is a unique technology that deters odors and is a great clear air delivery system. Plasma dramatically reduces the harmful contaminants in the air and takes care of your well-being.



## Protects your home and your health

### HI-NANO

HI-NANO can effectively remove viruses and bacteria by releasing high concentration ions, creating a healthy environment and protecting health. HI-NANO has been proven to remove 92.6%\* H1N1 and sterilize 88.54%\* of E.coli in 2 hours. The Healthy high-concentration ions also can effectively remove airborne dust as HI-NANO has been proven to remove 60.07%\* of PM2.5 in 2 hours, purifying the air around you.

The HI-NANO technology has been proven safe and has been authorized to apply the UL mark.

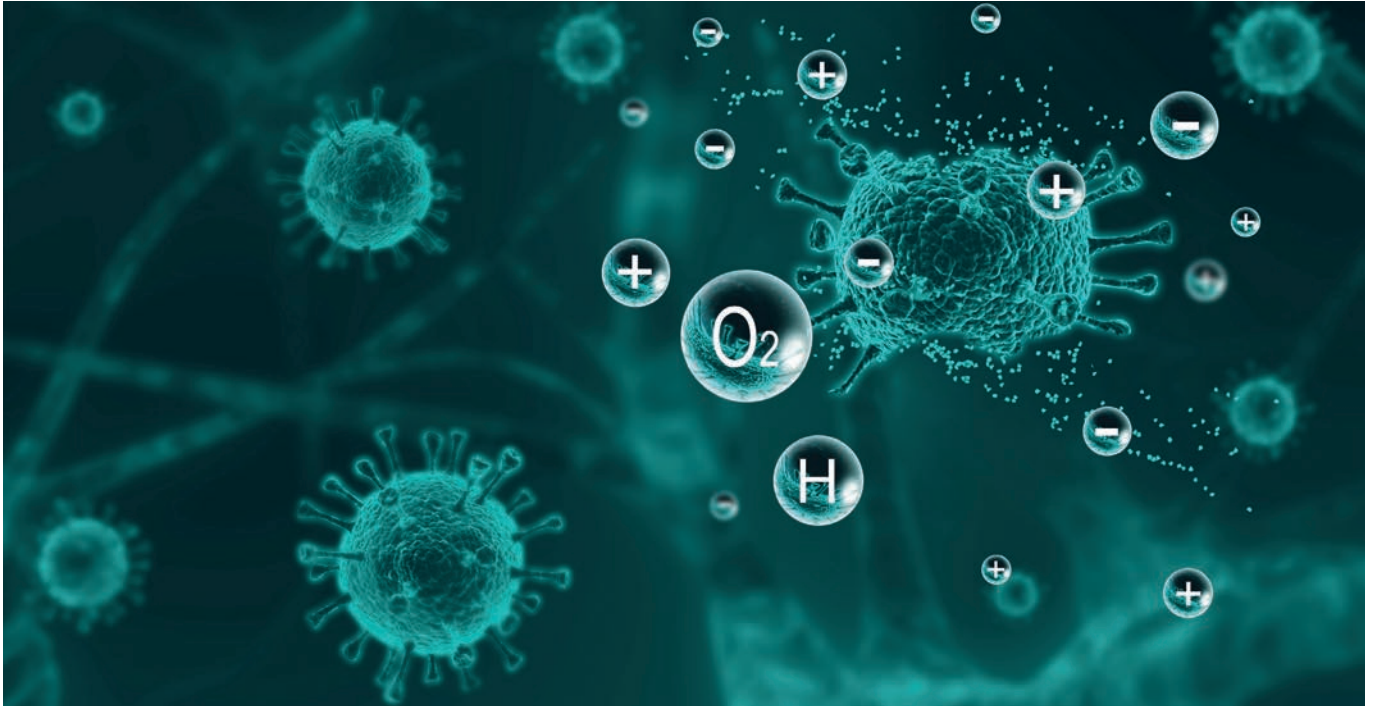

## Fresh air every day

### Fresh Air Technology

Due to the patented Fresh Air technology, the Hisense Fresh Master refreshes the whole room in just 3 minutes by introducing fresh and purified air from outdoors at a rate of 50m<sup>3</sup>/h. It detects CO<sub>2</sub> concentrations automatically, and signals the air quality on an LED display.



## High quality air assured

### Multi-layer air purifying technology

Air travels through multiple filters and each has the function to provide you with better and healthier air. The most common filters in our ACs are Vitamin C filter, Catechin filter, Silver Ion filter and HEPA filter.

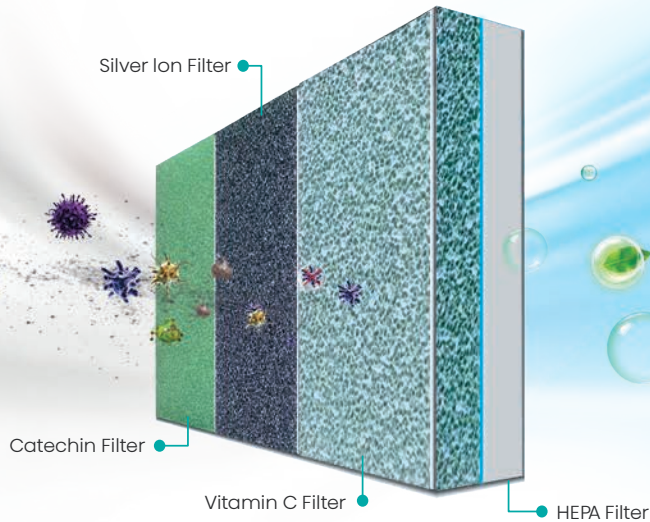

#### Catechin filter

Catechin is an extract from green tea, which, thanks to its oxidation and sterilization effects, is added to the filters. Active enzymes create a benzene core that absorbs unpleasant odor and harmful substances in the atmosphere. The catechin filter intercepts and sterilizes dust particles effectively and in the long term. Its antibacterial effect destroys more than 95% of bacteria.

#### HEPA filter

A highly efficient HEPA filter, which captures 80 % more of dust particles than classical filters, ensuring even fresher and purer ambient air.

#### Silver ion filter

Silver ion filter is a highly efficient sterilizing filter that effectively stops bacteria from growing.

#### Vitamin C

Vitamin C filters are an added protection that provides extremely clean air. Such pure air is healthy for the skin, as it does not cause itching, softens the skin and reduces stress while providing therapeutic benefits.

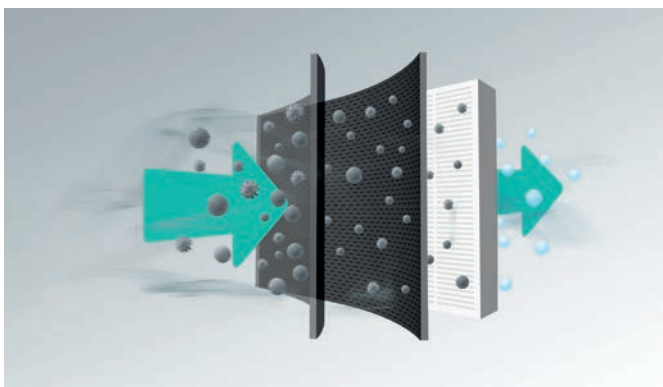

## Absorbs particles and unpleasant odour

### Active carbon filter

The Active Carbon filter includes a charcoal which in addition to particles, captures also chemicals, fumes, and cigarette smoke. Thus, it is the perfect solution to absorb and remove the air unpleasantness, so you can enjoy the fresh and clean air.

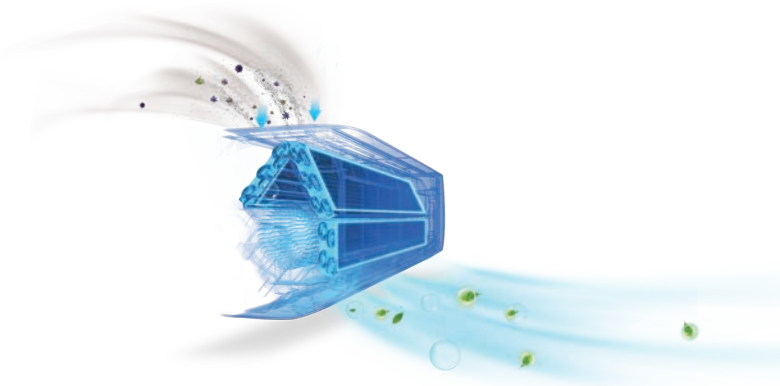

## Prevents mildew accumulation

### Mildew proof

After turning off the air conditioner, the indoor fan will keep running for additional 30 seconds to dry the evaporator. With preventing mildew accumulation on the evaporator, you will keep the air healthy.

# Comfort & practicality



 Follow

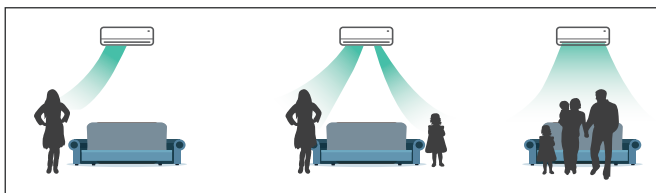

 Avoid

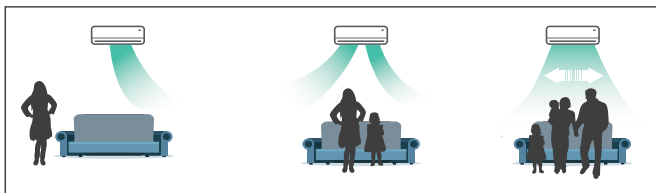

## Optimum air distribution

### Multi dimension airflow

The left and right independent air deflector design allow the user to control the wind by remote. The wind will follow or avoid people, so one will feel perfectly comfortable all the time.

## Smart sensing for perfect air deliverance

### Smart eye

The smart eye senses the position and heating flow information of human body and accordingly, adjusts the wind direction of the air conditioner. The wind will thus be smartly delivered to the user's area, so that one feels perfectly cool.

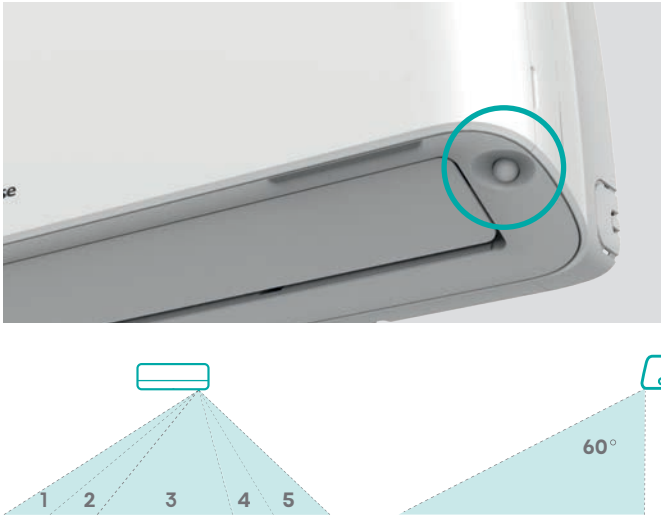

## Managing air purity easily

### Air Quality display

A special sensor is detecting the CO<sub>2</sub> concentration in the room, signaling you the quality of the air you breathe. The red icon indicates poor air quality, yellow indicates average quality, and green icon indicates good air quality. In case of red air quality, just turn on the Fresh air function and regain fresh air.



## Automatic louver swinging

### 4D auto swing

By automatic movement of horizontal louvers in a specific order, the device ensures optimum distribution and flow of cool or warm air through the room in all four directions.



## Intelligent control of temperature, humidity & wind speed

### TMS Comfort Control System

Hisense TMS technology is adopted to calculate the indoor environmental parameters which fit to users, based on six dimensions of temperature, humidity, wind speed, thermal radiation, clothing quantity and activity. It intelligently controls room temperature, humidity and wind speed.

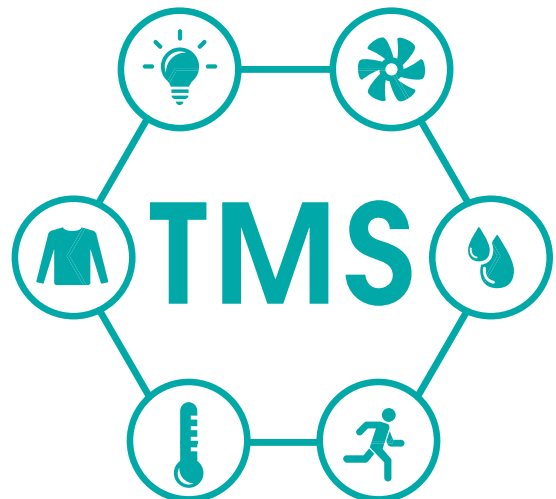

## Intelligence that works with you

### AI Smart

With just one button, you can wake up the intelligent air steward and control temperature, humidity, wind direction and air volume in an all-round way. There is no need to worry about how to use the air conditioner, AI will do it for you.

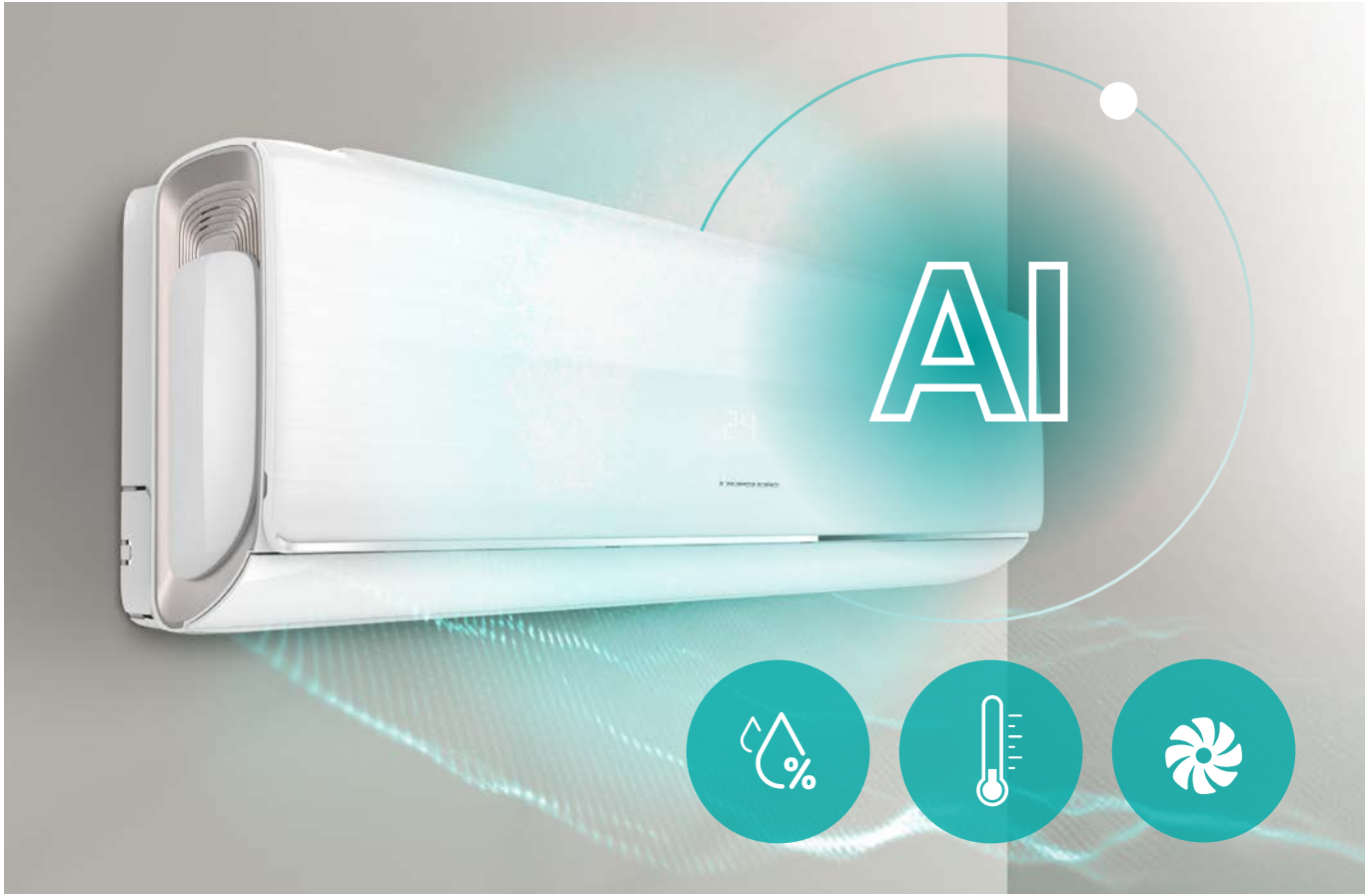

## Save energy & keep your home from freezing

### 8°C heating

In chilly winter, the special heating mode keeps your home from freezing, by maintain it at 8°. When you are away from home for long periods, you will save energy, protect the furniture and water pipes, or offer the comfortable situation for the pets.



## Super heating capacity

### Heating low to -22°C

Being able to provide heat in -22°C ambient is supported by our preheating technology and electric heating chassis technology. You will enjoy the sunny warm with perfect heating capacity in chilly winter.



## Best temperatures for everybody's vital sleep

### Four sleep modes

Sleep is vital for our body and resting comfortably brings benefits for our health. Selectable sleep modes are providing different sleep temperature, caring for all family members: adult, elderly, youth, children. The temperature curve will adjust automatically and intelligently, so you can fall asleep comfortably.

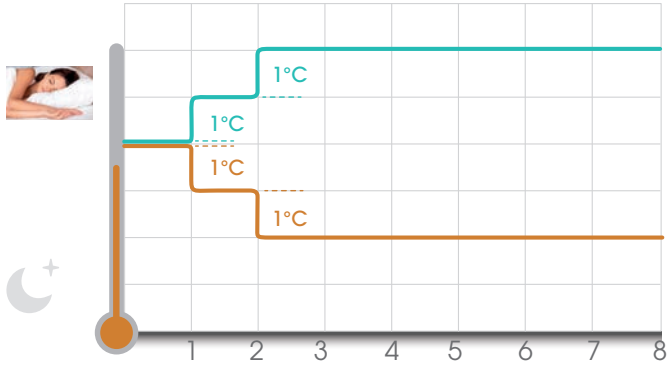

Common mode

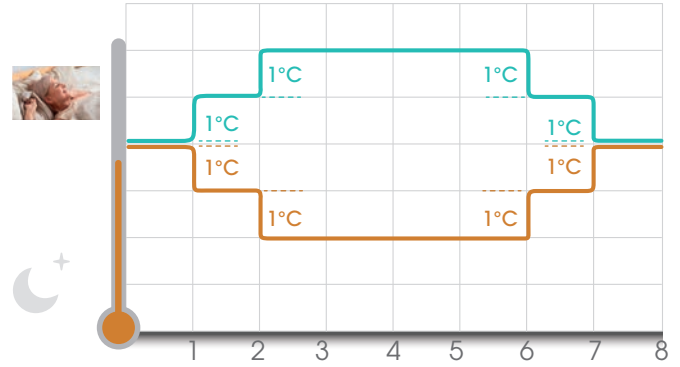

The elderly mode

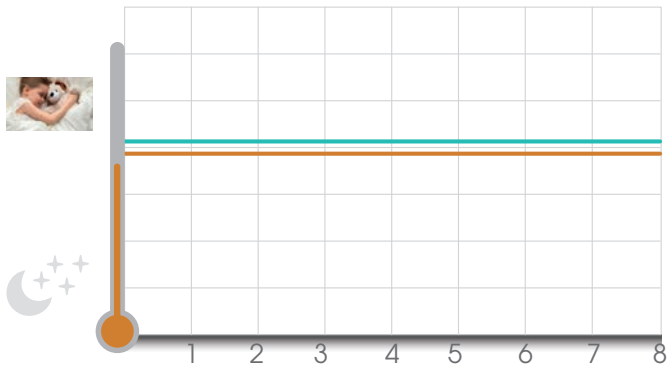

Children mode

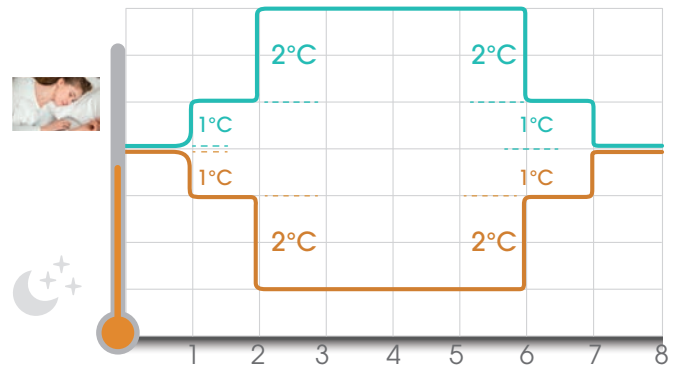

The youngsters mode

## Night mode operation

### Sleep mode

This function enables automatic increasing of set temperature by 2°C after one hour of operation. The temperature then remains constant and you can benefit from a comfortable sleep environment.



## Night mode for saving energy

### Dimmer

Press the dimmer button to turn off the light and the display in the unit. The air conditioner will save the energy and you will be able to enjoy the night mode of your space.





## Reducing noise to your convenience

### Silent operation

The noise lowers to 18dB (A), helping to give you a quiet and comfortable environment, making you feel like a walk on the moon.

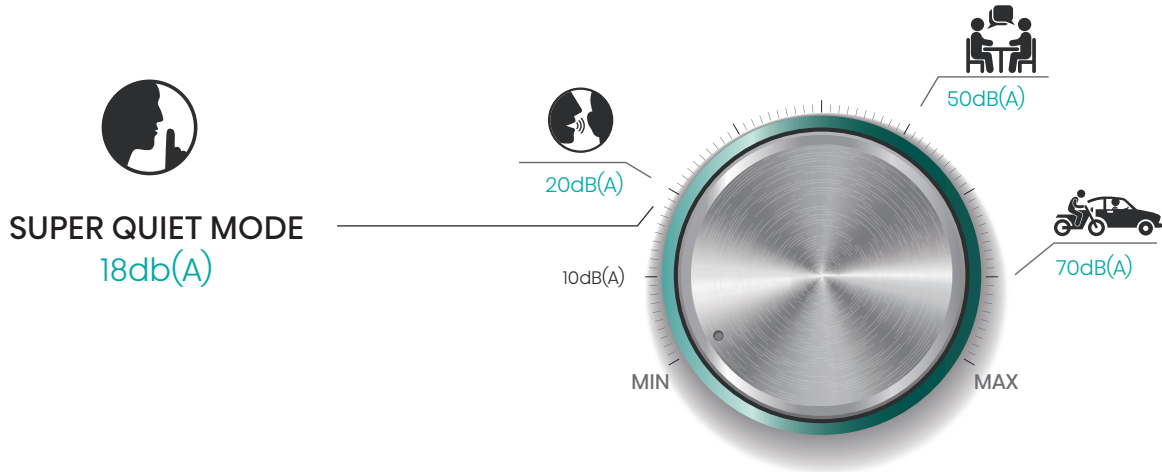

## Preset daily mode operation

### Timer 24 h

You can set a specific time during the day to have the AC automatically turned on or off. No worries, just a simple pleasure of all-ways being in right temperature.



## One click for perfect room temperature

### Smart mode

Just press the "Smart" button and the air conditioner will automatically adjust to the most comfortable temperature according to the room temperature.

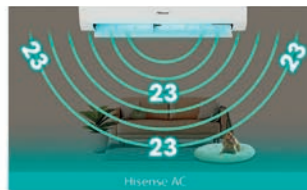
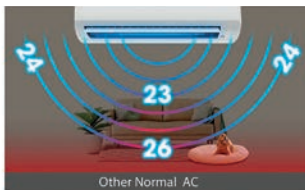

## Adjusting the temperature with remote

### I FEEL

The remote control measures the room temperature and relays the information to the unit. Not only the indoor temperature, but also the temperature around the user is transmitted to the indoor unit through the sensor on the wireless remote control. The indoor unit is operated and adjusted according to the perceived temperature to achieve intelligent temperature control in the room.



# Technical specifications

## Silentium Pro

R32 Full DC Inverter SCOP 5.1

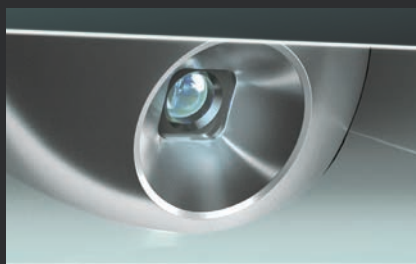

Smart Eye

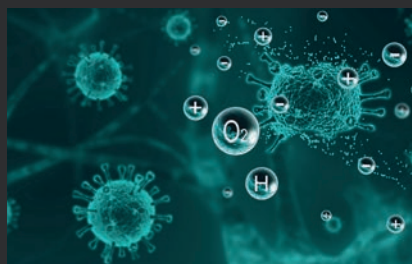

HI-NANO sterilization

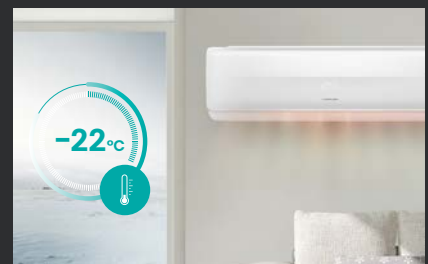

-22°C Low Ambient Heating (-22°C)

- Full DC Inverter
- High Energy Efficiency
- Self-diagnosis
- Humidity Control
- Outdoor Unit Chasis Heater
- Universal Unit
- 16 dB
- Smart Eye
- AI Smart
- Dual Self clean
- Smart air distribution
- Heating at -22 °C
- 8 °C Heating
- Comfortable Sleep Four Modes
- WiFi Control
- Voice Control
- Timer 24 h
- Wired Controller optional
- Room card control optional
- Child Lock
- Economy mode operation
- Antimold
- HI-NANO Sterilization
- TMS Comfort Control System
- Smart Mode
- Multi Anti-corrosion Protection
- 1W Standby
- Anti-bacteria Fin
- Dimmer

Model		QD25XU0E	QD35XU0E
Model name	Indoor Unit	QD25XU0EG	QD35XU0EG
	Outdoor Unit	QD25XU0EW	QD35XU0EW
Model code	Indoor Unit	20003794	20003795
	Outdoor Unit	20003844	20003845
Cooling Capacity	W	2600 (1000-4000)	3500 (1000-4400)
Rated Input-Cooling	W	535 (180-1050)	790 (180-900)
Rated Current Cooling	A	2.5	3.5
Heating Capacity	W	3200 (1600-4200)	4200 (1600-4800)
Rated Input-Heating	W	670 (300-1250)	980 (300-1280)
Rated Current Heating	A	3.0	4.3
Voltage, Frequency, Phase	V - Hz - Ph	220-240V-50Hz-1P	220-240V-50Hz-1P
SEER	Cooling	8.5	8.5
SCOP	Heating	5.1	5.1
Energy Class	Cooling	A+++	A+++
Energy Class	Heating	A+++	A+++
Moisture Removal	L/hour	0.9	1.2
<b>Air flow</b>			
Air Circulation (H/HM/M/ML/L)	m <sup>3</sup> /h	620/590/560/520/480/440	660/630/600/570/520/470
<b>Noise power/pressure</b>			
Indoor Unit Noise Level - Sound Power	dB (A)	53	51
Indoor Unit Noise Level - Sound Pressure (H/HM/M/ML/L/Quiet)	dB (A)	41/39/37/34/32/27	43/40/38/36/33/28
Outdoor Unit Noise Level - Sound Power	dB (A)	60	61
Outdoor Unit Noise Level - Sound Pressure	dB (A)	50	50
<b>Refrigerant</b>			
Refrigerant	/	R32	R32
Refrigerant charge volume	g	860	860
<b>Connecting Pipe Diameter</b>			
Liquid Pipe	inch (mm)	1/4 (6.35)	1/4 (6.35)
Gas Pipe	inch (mm)	3/8 (9.52)	3/8 (9.52)
Max length of pipe	m	20	20
Max height difference	m	10	10
<b>Dimensions</b>			
Net Dimensions - Indoor Unit	mm (WxHxD)	950×295×298	950×295×298
Net Dimensions - Outdoor Unit	mm (WxHxD)	810×585×280	810×585×280
Net Weight - Indoor Unit	kg	14	14
Net Weight - Outdoor Unit	kg	33	33
Packing Dimensions - Indoor Unit	mm (WxHxD)	1060×400×400	1060×400×400
Packing Dimensions - Outdoor Unit	mm (WxHxD)	940×630×385	940×630×385
Gross Weight - Indoor Unit	kg	17	17
Gross Weight - Outdoor Unit	kg	37	37
Loading Capacity (20°/40°/40°HC)	sets	72/147/171	72/147/171
<b>Operating temperature</b>			
Operating Temp Range	Cooling (°C)	- 15 °C - 43 °C	- 15 °C - 43 °C
	Heating (°C)	- 22 °C - 24 °C	- 22 °C - 24 °C
<b>Useful area</b>			
Max. useful area*	m <sup>2</sup>	14	24

\* Usable area depends on the building insulation and potential heat sources in the building.

# Technical specifications

## Fresh Master

R32

Full DC Inverter

SCOP 5.1



Fresh Air

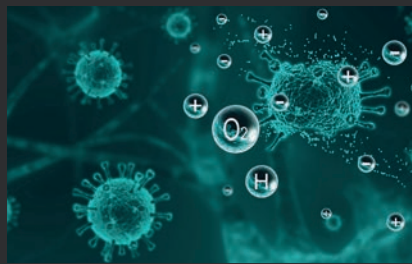

HI-NANO sterilization

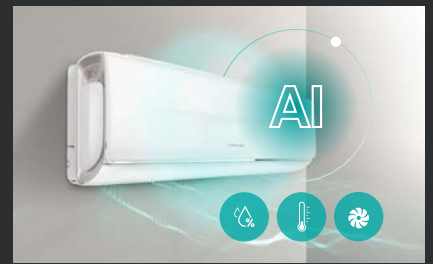

AI smart

- Full DC Inverter
- High Energy Efficiency
- Self-diagnosis
- Light-sensitive
- Outdoor Unit Chasis Heater
- Humidity Control
- Air quality monitoring
- 18 dB
- Fresh Air
- AI Smart
- Dual Self clean
- Ceiling airflow Floor airflow
- Heating at -22 °C
- 8 °C heating
- Comfortable Sleep Four Modes
- WiFi Control
- Voice Control
- Timer 24 h
- Child Lock
- Dimmer
- Air quality LED display
- Economy mode operation
- 4 in 1 Filter
- Antimold
- HI-NANO Sterilization
- Anti-bacteria Fin
- 4D Auto-swing
- 1W Standby
- Dual drainage
- Multi Anti-corrosion Protection
- Active Carbon Filter

Model		QF25XW0E	QF35XW0E
Model name	Indoor Unit	QF25XW0EG	QF35XW0EG
	Outdoor Unit	QF25XW0EW	QF35XW0EW
Model code	Indoor Unit	20004044	20004011
	Outdoor Unit	20006228	20004012
Cooling Capacity	W	2600 (1000-4000)	3500 (1000-4400)
Rated Input-Cooling	W	535 (180-1050)	810 (180-900)
Rated Current Cooling	A	2.4	3.6
Heating Capacity	W	3200 (1600-4200)	4200 (1600-4800)
Rated Input-Heating	W	720 (300-1250)	1040 (300-1280)
Rated Current Heating	A	3.2	4.6
Voltage, Frequency, Phase	V - Hz - Ph	220-240V ~ 50Hz, 1P	220-240V ~ 50Hz, 1P
SEER	Cooling	8.8	8.5
SCOP	Heating Average	5.1	5.1
SCOP	Heating Warmer	6.0	5.6
Energy Class	Cooling	A+++	A+++
Energy Class	Heating	A+++	A+++
Moisture Removal	L/hour	0.9	1.2
<b>Air flow</b>			
Air Circulation (H/HM/M/ML/L)	m <sup>3</sup> /h	580/550/500/450/400/350	630/610/560/510/460/410
<b>Noise power/pressure</b>			
Indoor Unit Noise Level - Sound Power	dB (A)	53	54
Indoor Unit Noise Level - Sound Pressure (H/HM/M/ML/L/Quiet)	dB (A)	37/35/33/30/28/26	37/35/33/30/28/26
Outdoor Unit Noise Level - Sound Power	dB (A)	60	62
Outdoor Unit Noise Level - Sound Pressure	dB (A)	50	50
<b>Refrigerant</b>			
Refrigerant	/	R32	R32
Refrigerant charge volume	g	860	860
<b>Connecting Pipe Diameter</b>			
Liquid Pipe	inch (mm)	1/4 (6.35)	1/4 (6.35)
Gas Pipe	inch (mm)	3/8 (9.52)	3/8 (9.52)
Max length of pipe	m	20	20
Max height difference	m	10	10
<b>Dimensions</b>			
Net Dimensions - Indoor Unit	mm (WxHxD)	978×313×217	978×313×217
Net Dimensions - Outdoor Unit	mm (WxHxD)	810×585×280	810×585×280
Net Weight - Indoor Unit	kg	13.5	13.5
Net Weight - Outdoor Unit	kg	33	33
Packing Dimensions - Indoor Unit	mm (WxHxD)	1060×430×400	1060×430×400
Packing Dimensions - Outdoor Unit	mm (WxHxD)	940×630×385	940×630×385
Gross Weight - Indoor Unit	kg	18.5	18.5
Gross Weight - Outdoor Unit	kg	37	37
Loading Capacity (20°/40°/40°HC)	sets	70/142/162	70/142/162
<b>Operating temperature</b>			
Operating Temp Range	Cooling (°C)	-15 °C - 43 °C	-15 °C - 43 °C
	Heating (°C)	-22 °C - 24 °C	-22 °C - 24 °C
<b>Useful area</b>			
Max. useful area*	m <sup>2</sup>	14	24

\* Usable area depends on the building insulation and potential heat sources in the building.

# Technical specifications

## Energy Pro Plus

R32

Full DC Inverter

SCOP 5.1





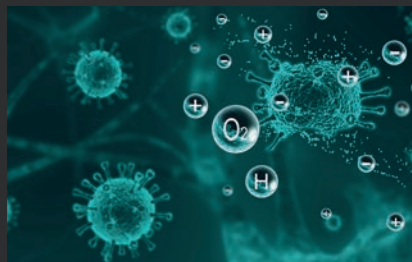



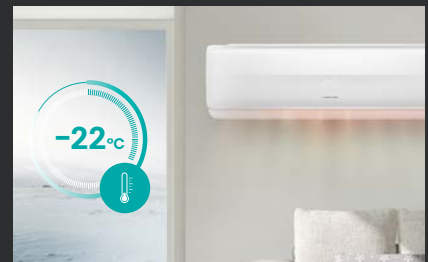



















Smart Eye



HI-NANO sterilization



-22°C Low Ambient Heating (-22°C)

-  HI-NANO Sterilization
-  4-in-1 filter & active carbon filter
-  Dual Self clean (indoor/outdoor)
-  Anti-bacteria Fin
-  Antimold
-  Smart Eye
-  TMS Comfort Control System
-  AI Smart
-  WiFi Control
-  Voice Control
-  4D Auto-swing
-  Multi Dimensional airflow
-  18 dB
-  Humidity Control
-  Timer 24 h
-  Fast Cooling
-  8 °C Heating
-  Heating at -22 °C
-  Child Lock
-  Universal Unit
-  Wired Controller optional
-  Room card control optional
-  Full DC Inverter
-  Self-diagnosis
-  Outdoor Unit Chasis Heater
-  High Energy Efficiency
-  Economy mode operation

Model		QG25XV0E	QG35XV0E
Model name	Indoor Unit	QG25XV0EG	QG35XV0EG
	Outdoor Unit	QG25XV0EW	QG35XV0EW
Model code	Indoor Unit	20009637	20009606
	Outdoor Unit	20009638	20009639
Cooling Capacity	W	2600 (1000-4000)	3500 (1000-4400)
Rated Input-Cooling	W	535 (180-1050)	790 (180-900)
Rated Current Cooling	A	2.5	3.5
Heating Capacity	W	3200 (1600-4200)	4200 (1600-4800)
Rated Input-Heating	W	720 (300-1250)	980 (300-1280)
Rated Current Heating	A	3.2	4.3
Voltage, Frequency, Phase	V - Hz - Ph	220-240V-50Hz-1P	220-240V-50Hz-1P
SEER	Cooling	8.8	8.5
SCOP	Heating	5.1	5.1
Energy Class	Cooling	A+++	A+++
Energy Class	Heating	A+++	A+++
Moisture Removal	L/hour	0.9	1.2
<b>Air flow</b>			
Air Circulation (H/HM/M/ML/L)	m <sup>3</sup> /h	620/590/560/520/480/440	660/630/600/570/520/470
<b>Noise power/pressure</b>			
Indoor Unit Noise Level - Sound Power	dB (A)	53	54
Indoor Unit Noise Level - Sound Pressure (H/HM/M/ML/L/Quiet)	dB (A)	38/35/34/31/29/25	38/36/33/32/30/25
Outdoor Unit Noise Level - Sound Power	dB (A)	60	61
Outdoor Unit Noise Level - Sound Pressure	dB (A)	50	50
<b>Refrigerant</b>			
Refrigerant	/	R32	R32
Refrigerant charge volume	g	860	860
<b>Connecting Pipe Diameter</b>			
Liquid Pipe	inch (mm)	1/4 (6.35)	1/4 (6.35)
Gas Pipe	inch (mm)	3/8 (9.52)	3/8 (9.52)
Max length of pipe	m	20	20
Max height difference	m	10	10
<b>Dimensions</b>			
Net Dimensions - Indoor Unit	mm (WxHxD)	835×305×198	835×305×198
Net Dimensions - Outdoor Unit	mm (WxHxD)	810×585×280	810×585×280
Net Weight - Indoor Unit	kg	10	10
Net Weight - Outdoor Unit	kg	33	33
Packing Dimensions - Indoor Unit	mm (WxHxD)	950×320×320	950×320×320
Packing Dimensions - Outdoor Unit	mm (WxHxD)	940×630×385	940×630×385
Gross Weight - Indoor Unit	kg	12.5	12.5
Gross Weight - Outdoor Unit	kg	37	37
Loading Capacity (20'/40'/40"HC)	sets	86/180/210	86/180/210
<b>Operating temperature</b>			
Operating Temp Range	Cooling (°C)	-15 °C - 43 °C	-15 °C - 43 °C
	Heating (°C)	-22 °C - 24 °C	-22 °C - 24 °C
<b>Useful area</b>			
Max. useful area*	m <sup>2</sup>	14	24

\* Usable area depends on the building insulation and potential heat sources in the building.

# Technical specifications

## Energy Pro

R32

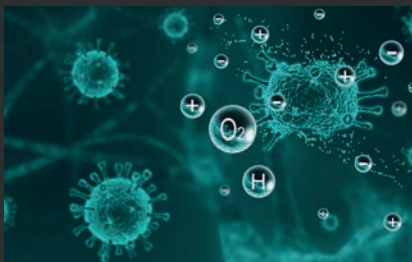
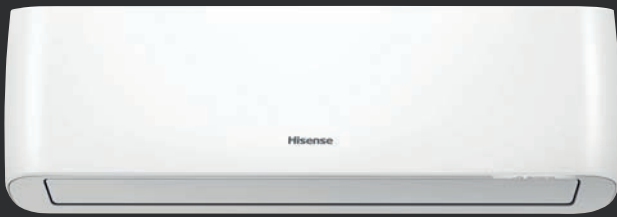
Full DC  
InverterSCOP  
5.1

HI-NANO sterilization

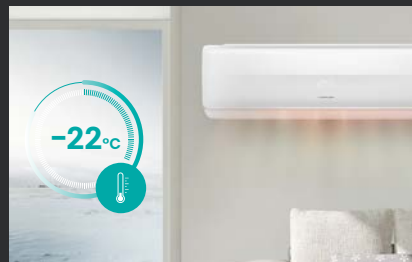

-22°C Low Ambient Heating (-22°C)



Dual Self-Clean



Full DC Inverter

High Energy  
Efficiency

Self-diagnosis



Humidity Control

Outdoor Unit  
Chasis Heater

Universal Unit



18 dB



Fast Cooling



AI Smart

Dual Self  
clean

4D Auto-swing

Heating  
at -22 °C

8 °C heating

Comfortable  
Sleep Four Modes

WiFi WiFi Control



Voice Control



Timer 24 h

Wired Controller  
optionalRoom card  
control optional

Child Lock

Economy mode  
operation

4 in 1 Filter



Antimold

HI-NANO  
SterilizationActive  
Carbon Filter

Anti-bacteria Fin

TMS Comfort  
Control System



Model		QE25XVOE	QE35XVOE
Model name	Indoor Unit	QE25XVOEG	QE35XVOEG
	Outdoor Unit	QE25XVOEW	QE35XVOEW
Model code	Indoor Unit	20003796	20003801
	Outdoor Unit	20003846	20003847
Cooling Capacity	W	2600 (1000-4000)	3500 (1000-4400)
Rated Input-Cooling	W	535 (180-1050)	790 (180-900)
Rated Current Cooling	A	2.5	3.5
Heating Capacity	W	3200 (1600-4200)	4200 (1600-4800)
Rated Input-Heating	W	720 (300-1250)	980 (300-1280)
Rated Current Heating	A	3.2	4.3
Voltage, Frequency, Phase	V - Hz - Ph	220-240V-50Hz-1P	220-240V-50Hz-1P
SEER	Cooling	8.8	8.5
SCOP	Heating	5.1	5.1
Energy Class	Cooling	A+++	A+++
Energy Class	Heating	A+++	A+++
Moisture Removal	L/hour	0.9	1.2
<b>Air flow</b>			
Air Circulation (H/HM/M/ML/L)	m <sup>3</sup> /h	620/590/560/520/480/440	660/630/600/570/520/470
<b>Noise power/pressure</b>			
Indoor Unit Noise Level - Sound Power	dB (A)	53	54
Indoor Unit Noise Level - Sound Pressure (H/HM/M/ML/L/Quiet)	dB (A)	38/35/34/31/29/25	38/36/33/32/30/25
Outdoor Unit Noise Level - Sound Power	dB (A)	60	61
Outdoor Unit Noise Level - Sound Pressure	dB (A)	50	50
<b>Refrigerant</b>			
Refrigerant	/	R32	R32
Refrigerant charge volume	g	860	860
<b>Connecting Pipe Diameter</b>			
Liquid Pipe	inch (mm)	1/4 (6.35)	1/4 (6.35)
Gas Pipe	inch (mm)	3/8 (9.52)	3/8 (9.52)
Max length of pipe	m	20	20
Max height difference	m	10	10
<b>Dimensions</b>			
Net Dimensions - Indoor Unit	mm (WxHxD)	835×305×198	835×305×198
Net Dimensions - Outdoor Unit	mm (WxHxD)	810×585×280	810×585×280
Net Weight - Indoor Unit	kg	10	10
Net Weight - Outdoor Unit	kg	33	33
Packing Dimensions - Indoor Unit	mm (WxHxD)	950×320×320	950×320×320
Packing Dimensions - Outdoor Unit	mm (WxHxD)	940×630×385	940×630×385
Gross Weight - Indoor Unit	kg	12.5	12.5
Gross Weight - Outdoor Unit	kg	37	37
Loading Capacity (20'/40'/40"HC)	sets	86/180/210	86/180/210
<b>Operating temperature</b>			
Operating Temp Range	Cooling (°C)	-15 °C - 43 °C	-15 °C - 43 °C
	Heating (°C)	-22 °C - 24 °C	-22 °C - 24 °C
<b>Useful area</b>			
Max. useful area*	m <sup>2</sup>	14	24

\* Usable area depends on the building insulation and potential heat sources in the building.

# Technical specifications

## Energy SE

R32

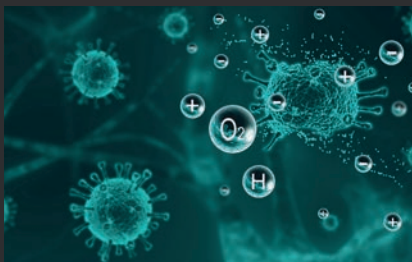
Full DC  
InverterSCOP  
4.6

HI-NANO sterilization

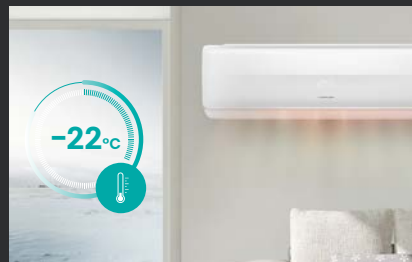

-22°C Low Ambient Heating (-22°C)



Outdoor unit chassis heater



Full DC Inverter



High Energy Efficiency



Self-diagnosis



Fire-proof PCB box



Outdoor Unit Chassis Heater



Universal Unit



19 dB



Fast Cooling



Indoor Self Clean



4D Auto-swing



Heating at -22°C



8°C heating



Comfortable Sleep



WiFi Control



Voice Control



Timer 24 h



Wired Controller optional



Room card control optional



Economy mode operation



Active Carbon Filter



4 in 1 Filter



HI-NANO Sterilization



Anti-bacteria Fin

Model		KA25MROE	KA35XROE	KA50BSOE	KA70KTOE
Model name	Indoor Unit	KA25MROEG	KA35XROEG	KA50BSOEG	KA70KTOEG
	Outdoor Unit	KA25MROEW	KA35XROEW	KA50BSOEW	KA70KTOEW
Model code	Indoor Unit	20003817	20003818	20003819	20003821
	Outdoor Unit	20003848	20003849	20003850	20003851
Cooling Capacity	W	2600 (800-3200)	3500 (1000-4000)	5000 (1500-6300)	7000 (1600-7800)
Rated Input-Cooling	W	590 (170-1400)	890 (190-1500)	1295 (260-1800)	2000(420-2760)
Rated Current Cooling	A	2.6	4	5.8	8.9
Heating Capacity	W	3000 (800-3300)	3900 (1000-4400)	5400 (1600-6200)	7500 (1800-8000)
Rated Input-Heating	W	720 (170-1500)	1000 (190-1600)	1380 (320-1650)	2100 (395-2850)
Rated Current Heating	A	3.2	4.5	6.2	9.4
Voltage, Frequency, Phase	V - Hz - Ph	220-240V ~ 50Hz, 1P	220-240V ~ 50Hz, 1P	220-240V ~ 50Hz, 1P	220-240V ~ 50Hz, 1P
SEER	Cooling	8.5	8.5	7.8	7.9
SCOP	Heating Average	4.6	4.6	4.6	4.6
SCOP	Heating Warmer	5.2	5.1	5.1	5.1
Energy Class	Cooling	A+++	A+++	A++	A++
Energy Class	Heating	A++	A++	A++	A++
Moisture Removal	L/hour	0.9	1.2	2	2.2
<b>Air flow</b>					
Air Circulation (H/HM/M/ML/L)	m <sup>3</sup> /h	520	580	950	1100
<b>Noise power/pressure</b>					
Indoor Unit Noise Level - Sound Power	dB (A)	56	56	60	63
Indoor Unit Noise Level - Sound Pressure (H/HM/M/ML/L/Quiet)	dB (A)	39/37/35/33/31/25	40/38/35/33/31/26	44/42/39/37/35/31	45/42/40/38/36/32
Outdoor Unit Noise Level - Sound Power	dB (A)	61	62	63	67
Outdoor Unit Noise Level - Sound Pressure	dB (A)	53	54	56	58
<b>Refrigerant</b>					
Refrigerant	/	R32	R32	R32	R32
Refrigerant charge volume	g	750	800	1150	1500
<b>Connecting Pipe Diameter</b>					
Liquid Pipe	inch (mm)	1/4 (6.35)	1/4 (6.35)	1/4 (6.35)	3/8 (9.52)
Gas Pipe	inch (mm)	3/8 (9.52)	3/8 (9.52)	1/2 (12.7)	5/8 (15.87)
Max length of pipe	m	20	20	20	20
Max height difference	m	10	10	15	15
<b>Dimensions</b>					
Net Dimensions - Indoor Unit	mm (WxHxD)	798x256x191	798x256x191	896x300x214	1008x325x217
Net Dimensions - Outdoor Unit	mm (WxHxD)	780x540x260	810x585x280	860x667x310	900x750x340
Net Weight - Indoor Unit	kg	7.5	7.6	10.5	12
Net Weight - Outdoor Unit	kg	28	33	39	49
Packing Dimensions - Indoor Unit	mm (WxHxD)	850x320x260	850x320x260	960x360x300	1120x390x315
Packing Dimensions - Outdoor Unit	mm (WxHxD)	910x600x360	940x630x385	995x720x420	1060x820x450
Gross Weight - Indoor Unit	kg	9.2	9.2	12.5	14.5
Gross Weight - Outdoor Unit	kg	31.5	37	45	54
Loading Capacity (20°/40°/40°HC)	sets	112/222/264	98/198/230	72/140/164	52/108/124
<b>Operating temperature</b>					
Operating Temp Range	Cooling (°C)	-15 °C - 43 °C	-15 °C - 43 °C	-15 °C - 43 °C	-15 °C - 43 °C
	Heating (°C)	-22 °C - 24 °C	-22 °C - 24 °C	-22 °C - 24 °C	-22 °C - 24 °C
<b>Useful area</b>					
Max. useful area*	m <sup>2</sup>	14	24	28	38

\* Usable area depends on the building insulation and potential heat sources in the building.

# Technical specifications

## Apple Pie Pro

R32

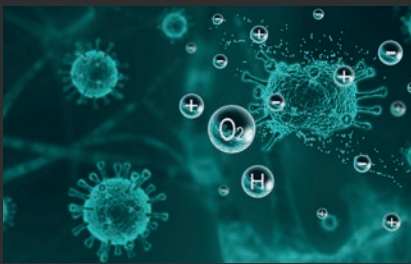
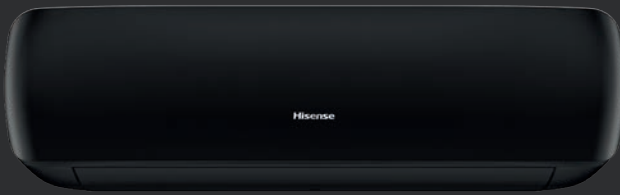
SCOP  
4

HI-NANO sterilization



Outdoor unit chassis heater

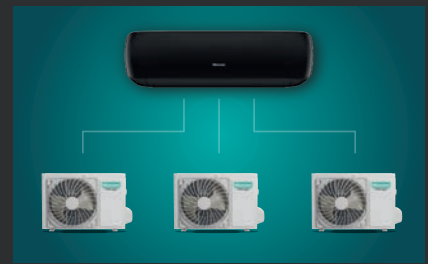

Universal Unit

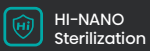
HI-NANO  
Sterilization4-in-1 filter &  
active carbon  
filter

Anti-bacteria Fin



Indoor Self Clean



Smart Mode



WiFi Control



4D Auto-swing

Comfortable  
Sleep

19 dB



Dimmer



Timer 24 h



Fast Cooling



8 °C heating

Heating  
at -20 °CFire-proof  
PCB box

Universal Unit

Wired Controller  
optionalRoom card  
control optionalLeft/Right  
Draining

Self-diagnosis

Outdoor Unit  
Chasis HeaterEconomy mode  
operationLED Hidden  
Display

3 min Protection



IW Standby

Model		TG25VE0E	TG35VE0E	TG50XA0E
Model name	Indoor Unit	TG25VE0EG	TG35VE0EG	TG50XA0EG
	Outdoor Unit	TG25VE0EW	TG35VE0EW	TG50XA0EW
Model code	Indoor Unit	20009607	20009608	20009609
	Outdoor Unit	20009640	20009641	20009642
Cooling Capacity	W	2600 (800-3500)	3500 (1200-4100)	5000 (1000-6000)
Rated Input-Cooling	W	735 (180-1500)	1000 (190-1500)	1540 (260-2300)
Rated Current Cooling	A	3,3	4,4	6,8
Heating Capacity	W	2800 (800-3500)	4000 (1600-4300)	5600 (1600-6250)
Rated Input-Heating	W	680 (180-1500)	1025 (190-1500)	1550 (350-2300)
Rated Current Heating	A	3,1	4,5	7
Voltage, Frequency, Phase	V - Hz - Ph	220-240V~, 50Hz, 1P	220-240V~, 50Hz, 1P	220-240V~, 50Hz, 1P
SEER	Cooling	6,1	6,1	6,1
SCOP	Heating	4	4	4
Energy Class	Cooling	A++	A++	A++
Energy Class	Heating	A+	A+	A+
Moisture Removal	L/hour	0,9	1,2	2,0
<b>Air flow</b>				
Air Circulation	m <sup>3</sup> /h	550	600	1000
<b>Noise power/pressure</b>				
Indoor Unit Noise Level - Sound Power	dB (A)	56	56	60
Indoor Unit Noise Level - Sound Pressure	dB (A)	39/38/36/34/31/26	38/36/34/31/29/27	45/43/41/38/36/33
Outdoor Unit Noise Level - Sound Power	dB (A)	63	63	65
Outdoor Unit Noise Level - Sound Pressure	dB (A)	53	53	55
<b>Refrigerant</b>				
Refrigerant		R32	R32	R32
Refrigerant charge volume	g	590	760	1200
<b>Connecting Pipe Diameter</b>				
Liquid Pipe	inch (mm)	1/4 (6.35)	1/4 (6.35)	1/4 (6.35)
Gas Pipe	inch (mm)	3/8 (9.52)	3/8 (9.52)	1/2 (12.7)
Max length of pipe	m	20	20	20
Max height difference	m	10	10	15
<b>Dimensions</b>				
Net Dimensions - Indoor Unit	mm (WxHxD)	950×272×207	950×272×207	1050×320×235
Net Dimensions - Outdoor Unit	mm (WxHxD)	715×240×482	715×240×482	810×585×280
Net Weight - Indoor Unit	kg	9	9	12
Net Weight - Outdoor Unit	kg	26	27	38
Packing Dimensions - Indoor Unit	mm (WxHxD)	1000×335×260	1000×335×260	1118×392×318
Packing Dimensions - Outdoor Unit	mm (WxHxD)	830×315×530	830×315×530	940×385×630
Gross Weight - Indoor Unit	kg	11	11	15
Gross Weight - Outdoor Unit	kg	29	30	42
<b>Operating temperature</b>				
Operating Temp Range	Cooling (°C)	-15 °C - 43 °C	-15 °C - 43 °C	-15 °C - 43 °C
	Heating (°C)	-20 °C - 24 °C	-20 °C - 24 °C	-20 °C - 24 °C
<b>Useful area</b>				
Max. useful area*	m <sup>2</sup>	14	24	28

\* Usable area depends on the building insulation and potential heat sources in the building.

# Technical specifications

## New Comfort

R32

SCOP  
4







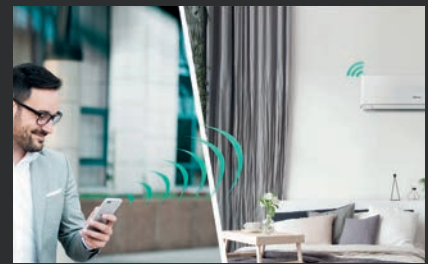

















Easy Installation



4D auto swing



Wi-Fi Control

-  Easy Installation
-  Easy Maintenance
-  Self-diagnosis
-  Fire-proof PCB box
-  Left/Right Draining
-  Universal Unit
-  19 dB
-  Fast Cooling
-  Smart Mode
-  Indoor Self Clean
-  4D Auto-swing
-  Heating at -20 °C
-  8 °C heating
-  Comfortable Sleep
-  WiFi Control
-  Timer 24 h
-  Dimmer
-  LED Hidden Display
-  Wired Controller optional
-  Room card control optional
-  Economy mode operation
-  4 in 1 Filter
-  HEPA Filter
-  Anti-bacteria Fin
-  Active Carbon Filter

Model		DJ25VE0B	DJ35VE0B	DJ50XA0B	DJ70BB0C
Model name	Indoor Unit	DJ25VE0BG	DJ35VE0BG	DJ50XA0BG	DJ70BB0CG
	Outdoor Unit	DJ25VE0BW	DJ35VE0BW	DJ50XA0BW	DJ70BB0CW
Model code	Indoor Unit	20002284	20000958	20002280	20002281
	Outdoor Unit	20002285	20000957	20002283	20002282
Cooling Capacity	W	2600 (800 - 3500)	3500 (1200 - 4100)	5000 (1000 - 6000)	7000 (2500 - 8000)
Rated Input-Cooling	W	735 (180 - 1500)	1000 (190 - 1500)	1540 (260 - 2300)	2230 (420 - 3000)
Rated Current Cooling	A	3.3	4.4	6.8	9.9
Heating Capacity	W	2800 (800 - 3500)	4000 (1600 - 4300)	5600 (1600 - 6250)	7100 (2500 - 8500)
Rated Input-Heating	W	680 (180 - 1500)	1025 (190 - 1500)	1550 (350 - 2300)	2240 (420 - 3200)
Rated Current Heating	A	3.1	4.5	7	9.9
Voltage, Frequency, Phase	V - Hz - Ph	220 - 240V~50Hz~1P	220 - 240V~50Hz~1P	220 - 240V~50Hz~1P	220 - 240V~50Hz~1P
SEER	Cooling	6.1	6.1	6.1	6.3
SCOP	Heating	4	4	4	4
Energy Class	Cooling	A++	A++	A++	A++
Energy Class	Heating	A+	A+	A+	A+
Moisture Removal	L/hour	0.9	1.2	2	2.5
<b>Air flow</b>					
Air Circulation	m <sup>3</sup> /h	550	600	1000	1100
<b>Noise power/pressure</b>					
Indoor Unit Noise Level - Sound Pressure	dB (A)	56	56	60	63
Indoor Unit Noise Level - Sound Power	dB (A)	39/37/35/33/31/25	40/38/35/33/31/26	44/42/39/37/35/31	45/42/40/38/36/32
Outdoor Unit Noise Level - Sound Pressure	dB (A)	63	63	65	68
Outdoor Unit Noise Level - Sound Power	dB (A)	53	53	55	58
<b>Refrigerant</b>					
Refrigerant	/	R32	R32	R32	R32
Refrigerant charge volume	g	590	760	1200	1440
<b>Connecting Pipe Diameter</b>					
Liquid Pipe	inch (mm)	1/4 (6.35)	1/4 (6.35)	1/4 (6.35)	3/8 (9.52)
Gas Pipe	inch (mm)	3/8 (9.52)	3/8 (9.52)	1/2 (12.7)	5/8 (15.87)
Max length of pipe	m	20	20	20	20
Max height difference	m	10	10	15	15
<b>Dimensions</b>					
Net Dimensions - Indoor Unit	mm (WxHxD)	815×270×212	815×270×212	915×315×235	1085×315×235
Net Dimensions - Outdoor Unit	mm (WxHxD)	715×240×482	715×240×482	810×585×280	860×667×310
Net Weight - Indoor Unit	kg	8.5	8.5	12	13
Net Weight - Outdoor Unit	kg	26	27	38	48
Packing Dimensions - Indoor Unit	mm (WxHxD)	870×335×265	870×335×265	1000×390×315	1170×390×315
Packing Dimensions - Outdoor Unit	mm (WxHxD)	830×315×530	830×315×530	940×385×630	995×720×420
Gross Weight - Indoor Unit	kg	10.5	10.5	14	15.5
Gross Weight - Outdoor Unit	kg	29	30	42	52
Loading Capacity (20'/40'/40'HC)	sets	140/283/320	140/283/320	86/174/197	61/131/150
<b>Operating temperature</b>					
Operating Temp Range	Cooling (°C)	-15 °C - 43 °C	-15 °C - 43 °C	-15 °C - 43 °C	-15 °C - 43 °C
	Heating (°C)	-20 °C - 24 °C	-20 °C - 24 °C	-20 °C - 24 °C	-20 °C - 24 °C
<b>Useful area</b>					
Max. useful area*	m <sup>2</sup>	14	24	28	38

\* Usable area depends on the building insulation and potential heat sources in the building.

# Technical specifications

## Wings Pro

R32

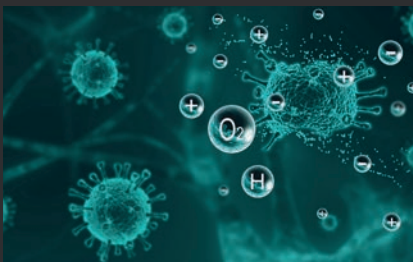
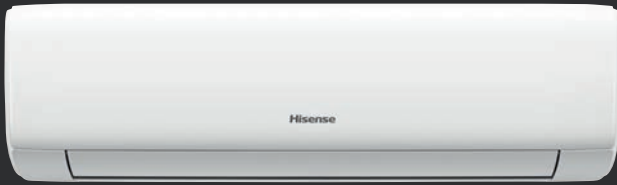
SCOP  
4

HI-NANO sterilization

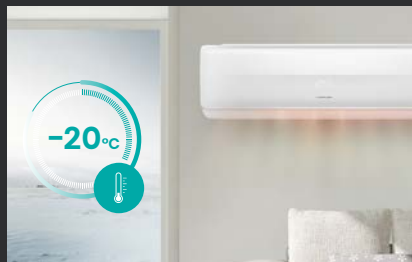

-20°C Low Ambient Heating (-20°C)

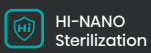

Outdoor unit chassis heater

HI-NANO  
Sterilization4-in-1 filter &  
active carbon  
filter

Anti-bacteria Fin



Indoor Self Clean



Antimold



I Feel



Smart Mode



WiFi Control

Comfortable  
Sleep

4D Auto-swing



19 dB



Dimmer



Timer 24 h



Fast Cooling



8 °C heating



Heating at -20 °C



Easy Installation

Easy  
MaintenanceLeft/Right  
DrainingWired Controller  
optionalRoom card  
control optionalOutdoor Unit  
Chasis HeaterEconomy mode  
operationLED Hidden  
Display

3 min Protection



Intelligent Defrost



Model		KB25YR3E	KB35YR3E	KB50XS1E	KB70BT1E
Model name	Indoor Unit	KB25YR3EG	KB35YR3EG	KB50XS1EG	KB70BT1EG
	Outdoor Unit	KB25YR3EW	KB35YR3EW	KB50XS1EW	KB70BT1EW
Model code	Indoor Unit	20003826	20003828	20003829	20003830
	Outdoor Unit	20003856	20003857	20003858	20003859
Cooling Capacity	W	2600 (1000-3000)	3400 (1000-4000)	5000 (1000-6000)	6500 (1600-7200)
Rated Input-Cooling	W	855 (190-1500)	1140 (190-1600)	1540 (260-2300)	2060 (420-2760)
Rated Current Cooling	A	3,9	5	6,9	9,2
Heating Capacity	W	2700 (1000-3000)	3800 (1000-4200)	5600 (1600-6250)	7100 (1800-7300)
Rated Input-Heating	W	700 (190-1500)	1050 (190-1600)	1550 (350-2300)	2150 (395-2700)
Rated Current Heating	A	3,1	4,7	7	9,6
Voltage, Frequency, Phase	V - Hz - Ph	220-240V~, 50Hz, 1P	220-240V~, 50Hz, 1P	220-240V~, 50Hz, 1P	220-240V~, 50Hz, 1P
SEER	Cooling	6,1	6,1	6,1	6,2
SCOP	Heating Average	4	4	4	4
SCOP	Heating Warmer	5,1	5,1	5,1	5,1
Energy Class	Cooling	A++	A++	A++	A++
Energy Class	Heating	A+	A+	A+	A+
Moisture Removal	L/hour	0,9	1,2	2,0	2,2
<b>Air flow</b>					
Air Circulation (H/HM/M/ML/L)	m <sup>3</sup> /h	550	550	880	1100
<b>Noise power/pressure</b>					
Indoor Unit Noise Level - Sound Power	dB (A)	56	56	59	64
Indoor Unit Noise Level - Sound Pressure (H/M-H/M/M-L/L/Quiet)	dB (A)	39/37/34/32/29/24	39/37/34/32/30/24	44/42/40/37/36/31	45/42/40/38/35/32
Outdoor Unit Noise Level - Sound Power	dB (A)	62	62	63	65
Outdoor Unit Noise Level - Sound Pressure	dB (A)	52	52	53	56
<b>Refrigerant</b>					
Refrigerant	/	R32	R32	R32	R32
Refrigerant charge volume	g	460	580	1150	1320
<b>Connecting Pipe Diameter</b>					
Liquid Pipe	inch (mm)	1/4 (6.35)	1/4 (6.35)	1/4 (6.35)	3/8 (9.52)
Gas Pipe	inch (mm)	3/8 (9.52)	3/8 (9.52)	1/2 (12.7)	5/8 (15.87)
Max length of pipe	m	20	20	20	20
Max height difference	m	10	10	15	15
<b>Dimensions</b>					
Net Dimensions - Indoor Unit	mm (WxHxD)	833×256×203	833×256×203	943×300×245	1039×325×237
Net Dimensions - Outdoor Unit	mm (WxHxD)	660×483×240	660×483×240	810×585×280	860×667×310
Net Weight - Indoor Unit	kg	7,7	7,7	10	11,0
Net Weight - Outdoor Unit	kg	21,7	22	34	41
Packing Dimensions - Indoor Unit	mm (WxHxD)	890×320×260	890×320×260	995×365×310	1120×390×315
Packing Dimensions - Outdoor Unit	mm (WxHxD)	780×530×315	780×530×315	940×630×385	995×720×420
Gross Weight - Indoor Unit	kg	9,5	9,5	12	13,5
Gross Weight - Outdoor Unit	kg	25	25	38,5	46
Loading Capacity (20°/40°/40°HC)	sets	150/310/342	150/310/342	86/178/202	66/134/152
<b>Operating temperature</b>					
Operating Temp Range	Cooling (°C)	-15 °C - 43 °C	-15 °C - 43 °C	-15 °C - 43 °C	-15 °C - 43 °C
	Heating (°C)	-20 °C - 24 °C	-20 °C - 24 °C	-20 °C - 24 °C	-20 °C - 24 °C
<b>Useful area</b>					
Max. useful area*	m <sup>2</sup>	14	24	28	38

\* Usable area depends on the building insulation and potential heat sources in the building.

# Technical specifications

## Expert Smart

R32

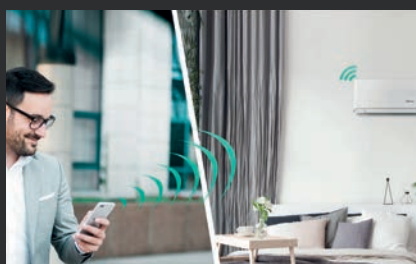
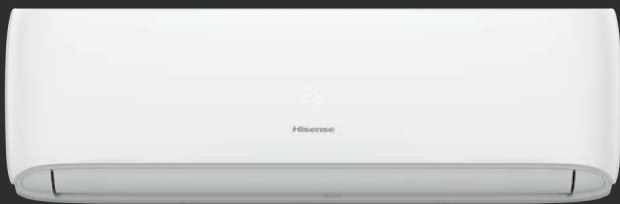
SCOP  
4

Wi-Fi Control



4D auto swing

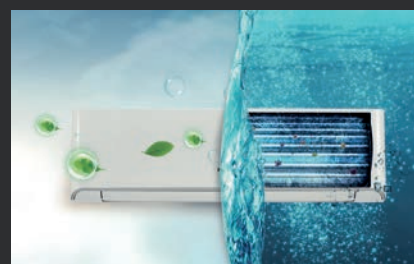

Self-Clean



Indoor Self Clean



Carbon Filter



Anti-bacteria Fin



Antimold



I Feel



Smart Mode



WiFi Control

Comfortable  
Sleep Four  
Modes

4D Auto-swing



19 dB



Dimmer



Timer 24 h



Fast Cooling



8 °C heating



Heating at -20 °C



Easy Installation

Easy  
MaintenanceLeft/Right  
DrainingWired Controller  
optionalRoom card  
control optionalEconomy mode  
operationLED Hidden  
Display

3 min Protection



Intelligent Defrost

Model		CF25YRIF	CF35YRIF	CF50XSIF	CF70BTIF
Model name	Indoor Unit	CF25YRIFG	CF35YRIFG	CF50XSIFG	CF70BTIFG
	Outdoor Unit	CF25YRIFW	CF35YRIFW	CF50XSIFW	CF70BTIFW
Model code	Indoor Unit	20009628	20009629	20009695	20009631
	Outdoor Unit	20009647	20009648	20009649	20009650
Cooling Capacity	W	2600 (1000-3000)	3400 (1000-4000)	5000 (1000-6000)	6500 (1600-7200)
Rated Input-Cooling	W	855 (190-1500)	1140 (190-1600)	1540 (260-2300)	2060 (420-2760)
Rated Current Cooling	A	3,9	5	6,9	9,2
Heating Capacity	W	2700 (1000-3000)	3800 (1000-4200)	5600 (1600-6250)	7100 (1800-7300)
Rated Input-Heating	W	680 (180-1500)	1025 (190-1500)	1550 (350-2300)	2240 (420-3200)
Rated Current Heating	A	3,1	4,7	7	9,6
Voltage, Frequency, Phase	V - Hz - Ph	220-240V~, 50Hz, 1P	220-240V~, 50Hz, 1P	220-240V~, 50Hz, 1P	220-240V~, 50Hz, 1P
SEER	Cooling	6,1	6,1	6,1	6,2
SCOP	Heating	4	4	4	4
Energy Class	Cooling	A++	A++	A++	A++
Energy Class	Heating	A+	A+	A+	A+
Moisture Removal	L/hour	0,9	1,2	2,0	2,2
<b>Air flow</b>					
Air Circulation	m <sup>3</sup> /h	550	550	880	1100
<b>Noise power/pressure</b>					
Indoor Unit Noise Level - Sound Pressure	dB (A)	56	56	59	64
Indoor Unit Noise Level - Sound Power	dB (A)	39/37/34/32/29/24	39/37/34/32/30/24	44/42/40/37/36/31	45/42/40/38/35/32
Outdoor Unit Noise Level - Sound Pressure	dB (A)	62	62	63	65
Outdoor Unit Noise Level - Sound Power	dB (A)	52	52	53	56
<b>Refrigerant</b>					
Refrigerant	/	R32	R32	R32	R32
Refrigerant charge volume	g	460	580	1150	1320
<b>Connecting Pipe Diameter</b>					
Liquid Pipe	inch (mm)	1/4 (6.35)	1/4 (6.35)	1/4 (6.35)	3/8 (9.52)
Gas Pipe	inch (mm)	3/8 (9.52)	3/8 (9.52)	1/2 (12.7)	5/8 (15.87)
Max length of pipe	m	20	20	20	20
Max height difference	m	10	10	15	15
<b>Dimensions</b>					
Net Dimensions - Indoor Unit	mm (WxHxD)	795x255x197	795x255x197	890x300x223	998x325x225
Net Dimensions - Outdoor Unit	mm (WxHxD)	660x483x240	660x483x240	810x585x280	860x667x310
Net Weight - Indoor Unit	kg	7,1	7,1	10	11,0
Net Weight - Outdoor Unit	kg	21,7	22	34	41
Packing Dimensions - Indoor Unit	mm (WxHxD)	850x320x260	850x320x260	960x365x300	1060x390x315
Packing Dimensions - Outdoor Unit	mm (WxHxD)	780x530x315	780x530x315	940x630x385	995x720x420
Gross Weight - Indoor Unit	kg	8,6	8,6	12	13,5
Gross Weight - Outdoor Unit	kg	25	25	38,5	46
<b>Operating temperature</b>					
Operating Temp Range	Cooling (°C)	-15 °C - 43 °C	-15 °C - 43 °C	-15 °C - 43 °C	-15 °C - 43 °C
	Heating (°C)	-20 °C - 24 °C	-20 °C - 24 °C	-20 °C - 24 °C	-20 °C - 24 °C
<b>Useful area</b>					
Max. useful area*	m <sup>2</sup>	14	24	28	38

\* Usable area depends on the building insulation and potential heat sources in the building.

# Technical specifications

## Easy Smart

R32

SCOP  
4

Compact design



Four Sleep Modes

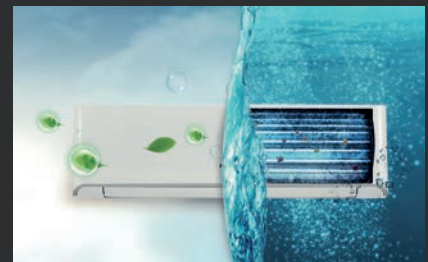

Self-Clean



Easy Maintenance



3 min Protection



1W Standby



Left/Right Draining



19 dB



Fast Cooling



Smart Mode



I Feel



Heating at -20 °C



8 °C heating



Comfortable Sleep Four Modes



Wifi Ready



Timer 24 h



Dimmer



LED Hidden Display



Wired Controller optional



Room card control optional



Economy mode operation



Active Carbon Filter



Antimold



Anti-bacteria Fin

Model		CA25YR03	CA35YR03	CA50XSIA	CA70BTIA
Model name	Indoor Unit	CA25YR03G	CA35YR03G	CA50XSIAG	CA70BTIAG
	Outdoor Unit	CA25YR03W	CA35YR03W	CA50XSIAW	CA70BTIAW
Model code	Indoor Unit	20003835	20003836	20001403	20001422
	Outdoor Unit	20003864	20003865	20001432	20001433
Cooling Capacity	W	2600 (1000-3000)	3400 (1000-4000)	5000 (1000-6000)	6500 (1600-7200)
Rated Input-Cooling	W	855 (190-1500)	1140 (190-1600)	1540 (260-2300)	2060 (420-2760)
Rated Current Cooling	A	3.9	5	6.9	9.2
Heating Capacity	W	2700 (1000-3000)	3800 (1000-4200)	5600 (1600-6250)	7100 (1800-7300)
Rated Input-Heating	W	700 (190-1500)	1050 (190-1600)	1550 (350-2300)	2150 (395-2700)
Rated Current Heating	A	3.1	4.7	7	9.3
Voltage, Frequency, Phase	V - Hz - Ph	220-240V~50Hz~1P	220-240V~50Hz~1P	220-240V~50Hz~1P	220-240V~50Hz~1P
SEER	Cooling	6.1	6.1	6.1	6.2
SCOP	Heating	4	4	4	4
Energy Class	Cooling	A++	A++	A++	A++
Energy Class	Heating	A+	A+	A+	A+
Moisture Removal	L/hour	0.9	1.2	2.0	2.2
<b>Air flow</b>					
Air Circulation	m <sup>3</sup> /h	550	550	880	1100
<b>Noise power/pressure</b>					
Indoor Unit Noise Level - Sound Power	dB (A)	56	56	59	64
Indoor Unit Noise Level - Sound Pressure (H/HM/M/ML/L/Quiet)	dB (A)	39/37/34/32/29/24	39/37/34/32/30/24	44/42/40/37/36/31	45/42/40/38/35/32
Outdoor Unit Noise Level - Sound Power	dB (A)	62	62	63	65
Outdoor Unit Noise Level - Sound Pressure	dB (A)	52	52	53	56
<b>Refrigerant</b>					
Refrigerant	/	R32	R32	R32	R32
Refrigerant charge volume	g	460	580	1150	1320
<b>Connecting Pipe Diameter</b>					
Liquid Pipe	inch (mm)	1/4 (6.35)	1/4 (6.35)	1/4 (6.35)	3/8 (9.52)
Gas Pipe	inch (mm)	3/8 (9.52)	3/8 (9.52)	1/2 (12.7)	5/8 (15.87)
Max length of pipe	m	20	20	20	20
Max height difference	m	10	10	15	15
<b>Dimensions</b>					
Net Dimensions - Indoor Unit	mm (WxHxD)	790×255×200	790×255×200	890×300×220	998×325×225
Net Dimensions - Outdoor Unit	mm (WxHxD)	660×483×240	660×483×240	810×585×280	860×667×310
Net Weight - Indoor Unit	kg	7.1	7.1	10	11.0
Net Weight - Outdoor Unit	kg	21.7	22	34	41
Packing Dimensions - Indoor Unit	mm (WxHxD)	850×325×255	850×325×255	960×365×300	1060×390×315
Packing Dimensions - Outdoor Unit	mm (WxHxD)	780×530×315	780×530×315	940×630×385	995×720×420
Gross Weight - Indoor Unit	kg	8.6	8.6	12	13.5
Gross Weight - Outdoor Unit	kg	25	25	38.5	46
Loading Capacity (20'/40'/40'HC) No Pipe	sets	158/316/352	158/316/352	88/182/208	66/136/157
<b>Operating temperature</b>					
Operating Temp Range	Cooling (°C)	-15 °C - 43 °C	-15 °C - 43 °C	-15 °C - 43 °C	-15 °C - 43 °C
	Heating (°C)	-20 °C - 24 °C	-20 °C - 24 °C	-20 °C - 24 °C	-20 °C - 24 °C
<b>Useful area</b>					
Max. useful area*	m <sup>2</sup>	14	24	28	38

\* Usable area depends on the building insulation and potential heat sources in the building.

# Technical specifications

## Wings

R32

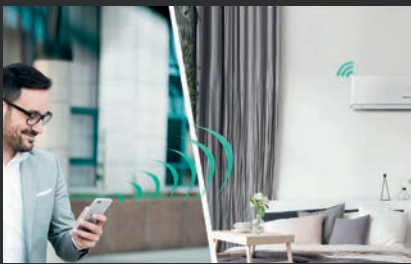
SCOP  
4

Wi-Fi Control



Cold Plasma Generator

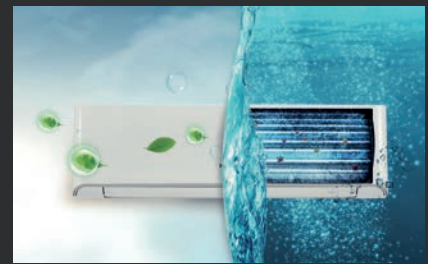

Self-Clean

 WiFi Control

 3 min Protection

 Left/Right Draining

 Intelligent Defrost

 19 dB

 Fast Cooling

 Smart Mode

 I Feel

 Heating at -20 °C

 8 °C heating

 Timer 24 h

 Dimmer

 LED Hidden Display

 Wired Controller optional

 Room card control optional

 Economy mode operation

 4 in 1 Filter

 Antimold

 Anti-bacteria Fin

 Active Carbon Filter

 4D Auto-swing

Note: WINGS PRO includes HI-NANO and Outdoor unit chasis heater (Heating belt) features, without Active carbon filter and cold plasma generator.

Model		KB25YR3F	KB35YR3F	KB50XS1F	KB70BT1F
Model name	Indoor Unit	KB25YR3FG	KB35YR3FG	KB50XS1FG	KB70BT1FG
	Outdoor Unit	KB25YR3FW	KB35YR3FW	KB50XS1FW	KB70BT1FW
Model code	Indoor Unit	20003831	20003832	20003833	20003834
	Outdoor Unit	20003860	20003861	20003862	20003863
Cooling Capacity	W	2600 (1000-3000)	3400 (1000-4000)	5000 (1000-6000)	6500 (1600-7200)
Rated Input-Cooling	W	855 (190-1500)	1140 (190-1600)	1540 (260-2300)	2060 (420-2760)
Rated Current Cooling	A	3.9	5	6.9	9.2
Heating Capacity	W	2700 (1000-3000)	3800 (1000-4200)	5600 (1600-6250)	7100 (1800-7300)
Rated Input-Heating	W	700 (190-1500)	1050 (190-1600)	1550 (350-2300)	2150 (395-2700)
Rated Current Heating	A	3.1	4.7	7	9.6
Voltage, Frequency, Phase	V - Hz - Ph	220-240V ~ 50Hz, 1P	220-240V ~ 50Hz, 1P	220-240V ~ 50Hz, 1P	220-240V ~ 50Hz, 1P
SEER	Cooling	6.1	6.1	6.1	6.2
SCOP	Heating Average	4	4	4	4
SCOP	Heating Warmer	5.1	5.1	5.1	5.1
Energy Class	Cooling	A++	A++	A++	A++
Energy Class	Heating	A+	A+	A+	A+
Moisture Removal	L/hour	0.9	1.2	2	2.2
<b>Air flow</b>					
Air Circulation (H/HM/M/ML/L)	m <sup>3</sup> /h	550	550	880	1100
<b>Noise power/pressure</b>					
Indoor Unit Noise Level - Sound Power	dB (A)	56	56	59	63
Indoor Unit Noise Level - Sound Pressure (H/HM/M/ML/L/Quiet)	dB (A)	39/37/34/32/29/24	39/37/34/32/30/24	44/42/40/37/36/31	45/42/40/38/35/32
Outdoor Unit Noise Level - Sound Power	dB (A)	62	62	63	65
Outdoor Unit Noise Level - Sound Pressure	dB (A)	52	52	53	55
<b>Refrigerant</b>					
Refrigerant	/	R32	R32	R32	R32
Refrigerant charge volume	g	460	580	1150	1320
<b>Connecting Pipe Diameter</b>					
Liquid Pipe	inch (mm)	1/4 (6.35)	1/4 (6.35)	1/4 (6.35)	3/8 (9.52)
Gas Pipe	inch (mm)	3/8 (9.52)	3/8 (9.52)	1/2 (12.7)	5/8 (15.87)
Max length of pipe	m	20	20	20	20
Max height difference	m	10	10	15	15
<b>Dimensions</b>					
Net Dimensions - Indoor Unit	mm (WxHxD)	833×256×203	833×256×203	943×300×245	1032×327×227
Net Dimensions - Outdoor Unit	mm (WxHxD)	660×483×240	660×483×240	810×585×280	860×667×310
Net Weight - Indoor Unit	kg	7.7	7.7	10	11
Net Weight - Outdoor Unit	kg	21.7	22	34	42
Packing Dimensions - Indoor Unit	mm (WxHxD)	890×320×260	890×320×260	995×365×310	1120×390×315
Packing Dimensions - Outdoor Unit	mm (WxHxD)	780×530×315	780×530×315	940×630×385	995×720×420
Gross Weight - Indoor Unit	kg	9.5	9.5	12	13.5
Gross Weight - Outdoor Unit	kg	25	25	38.5	46
Loading Capacity (20°/40°/40°HC)	sets	150/310/342	150/310/342	86/178/202	66/134/152
<b>Operating temperature</b>					
Operating Temp Range	Cooling (°C)	-15 °C - 43 °C	-15 °C - 43 °C	-15 °C - 43 °C	-15 °C - 43 °C
	Heating (°C)	-20 °C - 24 °C	-20 °C - 24 °C	-20 °C - 24 °C	-20 °C - 24 °C
<b>Useful area</b>					
Max. useful area*	m <sup>2</sup>	14	24	28	38

\* Usable area depends on the building insulation and potential heat sources in the building.

# Technical specifications

## Mini Apple Pie

R32

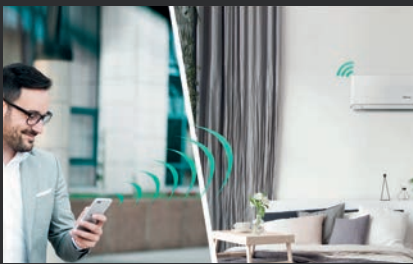
SCOP  
4

Wi-Fi Control



Fast cooling

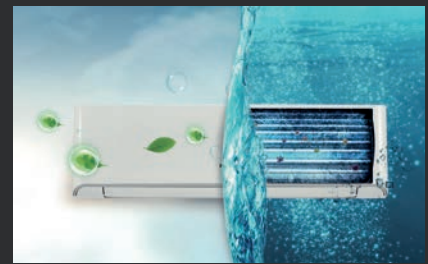

Self-Clean



3 min Protection



1W Standby



Self-diagnosis

Fire-proof  
PCB boxLeft/Right  
Draining

Universal Unit



19 dB



Fast cooling



Smart Mode



Indoor Self Clean



4D Auto-swing

Heating  
at -20 °C

8 °C heating

Comfortable  
Sleep

Wifi Ready



Timer 24 h



Dimmer

LED Hidden  
DisplayWired Controller  
optionalRoom card  
control optionalEconomy mode  
operation

High density Filter



4 in 1 Filter

Cold Plasma  
Sterilization



Model		TG25VE0B	TG35VE0B	TG50XA0B	TG70BB0C
Model name	Indoor Unit	TG25VE0BG	TG35VE0BG	TG50XA0BG	TG70BB0CG
	Outdoor Unit	TG25VE0BW	TG35VE0BW	TG50XA0BW	TG70BB0CW
Model code	Indoor Unit	20009621	20009622	20009623	20009624
	Outdoor Unit	20009643	20009644	20009645	20009646
Cooling Capacity	W	2600 (800-3500)	3500 (1200-4100)	5000 (1000-6000)	7000 (2500-8000)
Rated Input-Cooling	W	735 (180-1500)	1000 (190-1500)	1540 (260-2300)	2230 (420-3000)
Rated Current Cooling	A	3.3	4.4	6.8	9.9
Heating Capacity	W	2800 (800-3500)	4000 (1600-4300)	5600 (1600-6250)	7100 (2500-8500)
Rated Input-Heating	W	680 (180-1500)	1025 (190-1500)	1550 (350-2300)	2240 (420-3200)
Rated Current Heating	A	3.1	4.5	7	9.9
Voltage, Frequency, Phase	V - Hz - Ph	220-240V~50Hz~1P	220-240V~50Hz~1P	220-240V~50Hz~1P	220-240V~50Hz~1P
SEER	Cooling	6.1	6.1	6.1	6.3
SCOP	Heating	4	4	4	4
Energy Class	Cooling	A++	A++	A++	A++
Energy Class	Heating	A+	A+	A+	A+
Moisture Removal	L/hour	0.9	1.2	2.0	2.5
<b>Air flow</b>					
Air Circulation	m <sup>3</sup> /h	550	600	1000	1100
<b>Noise power/pressure</b>					
Indoor Unit Noise Level - Sound Pressure	dB (A)	56	56	60	65
Indoor Unit Noise Level - Sound Power	dB (A)	38/36/33/31/29/26	38/36/34/31/29/27	45/43/41/38/36/33	46/44/42/40/37/33
Outdoor Unit Noise Level - Sound Pressure	dB (A)	63	63	65	68
Outdoor Unit Noise Level - Sound Power	dB (A)	53	53	55	58
<b>Refrigerant</b>					
Refrigerant	/	R32	R32	R32	R32
Refrigerant charge volume	g	590	760	1200	1440
<b>Connecting Pipe Diameter</b>					
Liquid Pipe	inch (mm)	1/4 (6.35)	1/4 (6.35)	1/4 (6.35)	3/8 (9.52)
Gas Pipe	inch (mm)	3/8 (9.52)	3/8 (9.52)	1/2 (12.7)	5/8 (15.87)
Max length of pipe	m	20	20	20	20
Max height difference	m	10	10	15	15
<b>Dimensions</b>					
Net Dimensions - Indoor Unit	mm (WxHxD)	950X275X208	950X275X208	1050X320X235	1220X320X235
Net Dimensions - Outdoor Unit	mm (WxHxD)	715x240x480	715x240x480	810x585x280	860x667x310
Net Weight - Indoor Unit	kg	9	9	12	13
Net Weight - Outdoor Unit	kg	26	27	38	48
Packing Dimensions - Indoor Unit	mm (WxHxD)	1000x335x260	1000x335x260	1118x392x318	1315x392x318
Packing Dimensions - Outdoor Unit	mm (WxHxD)	830x315x530	830x315x530	940x385x630	995x720x420
Gross Weight - Indoor Unit	kg	11	11	15.5	15.5
Gross Weight - Outdoor Unit	kg	29	30	42	52
Loading Capacity (20'/40'/40'HC)	sets	133/275/320	133/275/320	81/168/184	61/125/144
<b>Operating temperature</b>					
Operating Temp Range	Cooling (°C)	-15 °C - 43 °C	-15 °C - 43 °C	-15 °C - 43 °C	-15 °C - 43 °C
	Heating (°C)	-20 °C - 24 °C	-20 °C - 24 °C	-20 °C - 24 °C	-20 °C - 24 °C
<b>Useful area</b>					
Max. useful area*	m <sup>2</sup>	14	24	28	38

\* Usable area depends on the building insulation and potential heat sources in the building.

# Technical specifications

## Eco Smart

R32

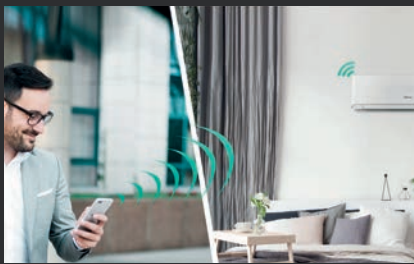
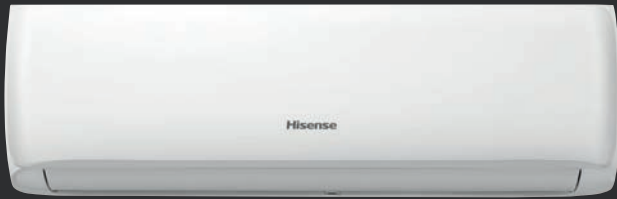
SCOP  
4

Wi-Fi Control



Installation kit\*

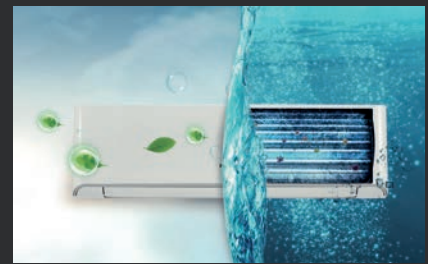

Self-Clean

Easy  
Maintenance

3 min Protection



1W Standby

Left/Right  
Draining

19 dB



Fast Cooling



Smart Mode



I Feel

Heating  
at -15 °C

8 °C heating

Comfortable  
Sleep Four Modes

Wifi Ready



Timer 24 h



Dimmer

LED Hidden  
DisplayWired Controller  
optionalRoom card  
control optionalEconomy mode  
operationActive  
Carbon Filter

Antimold



Anti-bacteria Fin

\*Note: Installation kit is optional

Model		CD25YR03	CD35YR03	CD50XSIA	CD70BTIA
Model name	Indoor Unit	CD25YR3FG	CD35YR3FG	CD50XSIFG	CD70BTIFG
	Outdoor Unit	CD25YR3FW	CD35YR3FW	CD50XSIFW	CD70BTIFW
Model code	Indoor Unit	20003055	20003056	20003057	20003058
	Outdoor Unit	20003870	20003871	20003872	20003873
Cooling Capacity	W	2600 (1000-3000)	3400 (1000-4000)	5000 (1000-6000)	6500 (1600-7200)
Rated Input-Cooling	W	855 (190-1500)	1140 (190-1600)	1540 (260-2300)	2060 (420-2760)
Rated Current Cooling	A	3.9	5	6.9	9.2
Heating Capacity	W	2700 (1000-3000)	3800 (1000-4200)	5600 (1600-6250)	7100 (1800-7300)
Rated Input-Heating	W	700 (190-1500)	1050 (190-1600)	1550 (350-2300)	2150 (395-2700)
Rated Current Heating	A	3.1	4.7	7	9.3
Voltage, Frequency, Phase	V - Hz - Ph	220-240V~50Hz~1P	220-240V~50Hz~1P	220-240V~50Hz~1P	220-240V~50Hz~1P
SEER	Cooling	6.1	6.1	6.1	6.2
SCOP	Heating	4	4	4	4
Energy Class	Cooling	A++	A++	A++	A++
Energy Class	Heating	A+	A+	A+	A+
Moisture Removal	L/hour	0.9	1.2	2	2.2
<b>Air flow</b>					
Air Circulation	m <sup>3</sup> /h	550	550	880	1100
<b>Noise power/pressure</b>					
Indoor Unit Noise Level - Sound Power	dB (A)	56	56	59	64
Indoor Unit Noise Level - Sound Pressure (H/HM/M/ML/L/Quiet)	dB (A)	39/37/34/32/30/24	39/37/34/32/30/24	44/42/40/37/36/31	45/42/40/38/35/32
Outdoor Unit Noise Level - Sound Power	dB (A)	62	62	63	65
Outdoor Unit Noise Level - Sound Pressure	dB (A)	51	52	55	56
<b>Refrigerant</b>					
Refrigerant	/	R32	R32	R32	R32
Refrigerant charge volume	g	460	580	1150	1320
<b>Connecting Pipe Diameter</b>					
Liquid Pipe	inch (mm)	1/4 (6.35)	1/4 (6.35)	1/4 (6.35)	3/8 (9.52)
Gas Pipe	inch (mm)	3/8 (9.52)	3/8 (9.52)	1/2 (12.7)	5/8 (15.87)
Max length of pipe	m	20	20	20	20
Max height difference	m	10	10	15	15
<b>Dimensions</b>					
Net Dimensions - Indoor Unit	mm (WxHxD)	790×255×203	790×255×203	890×300×227	998×325×232
Net Dimensions - Outdoor Unit	mm (WxHxD)	660×483×240	660×483×240	810×585×280	860×667×310
Net Weight - Indoor Unit	kg	7.1	7.1	10	11
Net Weight - Outdoor Unit	kg	21.7	22	34	41
Packing Dimensions - Indoor Unit	mm (WxHxD)	850×320×260	850×320×260	960×365×300	1060×390×315
Packing Dimensions - Outdoor Unit	mm (WxHxD)	780×530×315	780×530×315	940×630×385	995×720×420
Gross Weight - Indoor Unit	kg	8.6	8.6	12	13.5
Gross Weight - Outdoor Unit	kg	25	25	38.5	46
Loading Capacity (20'/40'/40'HC) No Pipe	sets	158/316/352	158/316/352	88/182/208	66/136/157
<b>Operating temperature</b>					
Operating Temp Range	Cooling (°C)	-15 °C - 43 °C	-15 °C - 43 °C	-15 °C - 43 °C	-15 °C - 43 °C
	Heating (°C)	-15 °C - 24 °C	-15 °C - 24 °C	-15 °C - 24 °C	-15 °C - 24 °C
<b>Useful area</b>					
Max. useful area*	m <sup>2</sup>	14	24	28	38

\* Usable area depends on the building insulation and potential heat sources in the building.

# Technical specifications

## V Pie

R410A

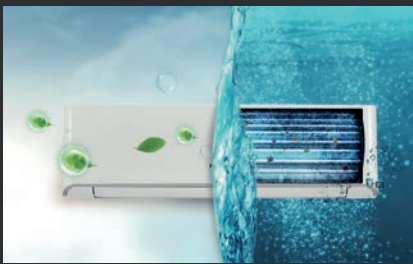
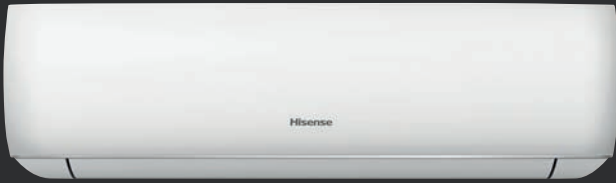
COP  
3.61

Self-Clean



Anti-bacterial fin



Fast cooling



Carbon Filter



Anti-bacteria Fin



Antimold



Easy Maintenance



I Feel



Smart Mode



Comfortable Sleep Four Modes



19 dB



Dimmer



Timer 24 h



Fast cooling



Left/Right Draining



Indoor Self Clean



Economy mode operation



3 min Protection



1W Standby



LED Hidden Display

Model		TV20YD1	TV25YD1	TV35VD1	TV50MA1
Model name	Indoor Unit	TV20YDIG	TV25YDIG	TV35VDIG	TV50MAIG
	Outdoor Unit	TV20YDIW	TV25YDIW	TV35VDIW	TV50MAIW
Model code	Indoor Unit	20003067	20003073	20003074	20003076
	Outdoor Unit	20003874	20003875	20003876	20003878
Cooling Capacity	W	2100	2700	3600	5100
Rated Input-Cooling	W	655	840	1121	1590
Rated Current Cooling	A	2.9	3.8	5	7.2
Heating Capacity	W	2200	2750	3700	5200
Rated Input-Heating	W	610	755	1025	1440
Rated Current Heating	A	2.7	3.4	4.6	6.5
Voltage, Frequency, Phase	V - Hz - Ph	220-240V~50Hz~1P	220-240V~50Hz~1P	220-240V~50Hz~1P	220-240V~50Hz~1P
EER	Cooling	3.21	3.21	3.21	3.21
COP	Heating	3.61	3.64	3.61	3.61
Energy Class	Cooling	A	A	A	A
Energy Class	Heating	A	A	A	A
Moisture Removal	L/hour	0.8	0.9	1.5	1.7
<b>Air flow</b>					
Air Circulation	m <sup>3</sup> /h	460	500	500	1050
<b>Noise power/pressure</b>					
Indoor Unit Noise Level - Sound Pressure	dB (A)	38	40	40	43
Indoor Unit Noise Level - Sound Power	dB (A)	53	53	55	54
<b>Refrigerant</b>					
Refrigerant	/	R410A	R410A	R410A	R410A
Refrigerant charge volume	g	550	680	850	1040
<b>Connecting Pipe Diameter</b>					
Liquid Pipe	inch (mm)	1/4 (6.35)	1/4 (6.35)	1/4 (6.35)	1/4 (6.35)
Gas Pipe	inch (mm)	3/8 (9.52)	3/8 (9.52)	1/2 (12.7)	1/2 (12.7)
Max length of pipe	m	15	15	15	20
Max height difference	m	5	5	5	10
<b>Dimensions</b>					
Net Dimensions - Indoor Unit	mm (WxHxD)	864×270×210	864×270×210	864×270×210	1042×238 × 315
Net Dimensions - Outdoor Unit	mm (WxHxD)	660×482×240	660×482×240	715×240×482	780×540×260
Net Weight - Indoor Unit	kg	8	8	8	12.5
Net Weight - Outdoor Unit	kg	21.5	24	27	38
Packing Dimensions - Indoor Unit	mm (WxHxD)	930×335×260	930×335×260	930×335×260	1118×392×318
Packing Dimensions - Outdoor Unit	mm (WxHxD)	780×530×315	780×530×315	830×530×315	910×600×360
Gross Weight - Indoor Unit	kg	9.5	9.5	10	14.5
Gross Weight - Outdoor Unit	kg	23	26	29	41
Loading Capacity (20°/40°/40°HC) With pipes	Sets	134/286/322	134/286/322	134/286/322	81/175/197
<b>Operating temperature</b>					
Operating Temp Range	Cooling (°C)	21 °C - 32 °C	21 °C - 32 °C	21 °C - 32 °C	21 °C - 32 °C
	Heating (°C)	-7 °C - 24 °C	-7 °C - 24 °C	-7 °C - 24 °C	-7 °C - 24 °C
<b>Useful area</b>					
Max. useful area*	m <sup>2</sup>	12	14	24	28

\* Usable area depends on the building insulation and potential heat sources in the building.

# Portable – J series

R290

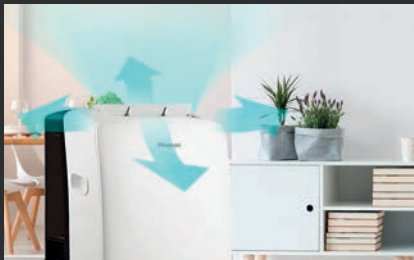

Auto swing



Timer 24h



Window kit



New gas  
NO F-Gas Cost



Self-diagnosis



Dehumidify



4 Casters for  
Easy Moving



Anti-bacteria Fin



Auto Swing



Fast Cooling



Smart Mode



Comfortable  
Sleep



Quiet Mode



Display Friendly



Timer 24 h



Remote Control



User Friendly  
Control & Display



Window kit

Model		APC09	APH09	APC12	APH12
Model Code		20001256	20001158	20001257	20001258
Type		T1, Cooling Only	T1, Heating Pump	T1, Cooling Only	T1, Heating Pump
<b>Ratings</b>					
Cooling Capacity	W	2600	2600	3500	3500
Heating Capacity	W	-	2400	-	3000
Moisture Removal	L/H.r	1	1	1,3	1,3
Air Circulation	m <sup>3</sup> /h	350	350	380	380
EER for Cooling	W/W	2,61	3,10	2,61	2,60
COP for Cooling	W/W	-	2,60	-	2,80
Energy Class	Cooling	A	A	A	A
Refrigerant		R290	R290	R290	R290
Refrigerant charge volume	g	160	165	285	300
Indoor Unit Noise Level (Sound Pressure)	High (dB (A))	52	52	54	54
	Mid (dB (A))	51	51	53	53
	Low (dB (A))	50	50	52	52
Indoor Unit Noise Level (Sound Power)	High (dB (A))	63	63	64	64
<b>Power Supply</b>					
Voltage, Frequency, Phase	V	220-240V ~ 50Hz ,1P	220-240V ~ 50Hz ,1P	220-240V ~ 50Hz ,1P	220-240V ~ 50Hz ,1P
Rated Current	Cooling (A)	4,4	4,3	5,9	6
	Heating (A)	/	4	/	5,2
<b>Features</b>					
Display Type		LED	LED	LED	LED
Sleep Mode		Yes (on the controller)	Yes (on the controller)	Yes (on the controller)	Yes (on the controller)
Dry Mode (auto speed only)		Yes	Yes	Yes	Yes
Water Full Indicator		Yes	Yes	Yes	Yes
Auto Cool (auto fan in cooling)		Yes (on the controller)	Yes (on the controller)	Yes (on the controller)	Yes (on the controller)
Smart Mode (remote access)		Yes (on the controller)	Yes (on the controller)	Yes (on the controller)	Yes (on the controller)
Rapid Cool(Jet) Mode (lowest temp & high speed) - remote only		Yes (on the controller)	Yes (on the controller)	Yes (on the controller)	Yes (on the controller)
Fan Only		Yes - 3 Speed	Yes - 3 Speed	Yes - 3 Speed	Yes - 3 Speed
Anion		No	No	No	No
Cooling Speed Selections		3	3	3	3
Timer- (24 Hr On/Off)		Yes- (24 Hr on/off - 1 minute Increments up to 24 Hrs)	Yes- (24 Hr on/off - 1 minute Increments up to 24 Hrs)	Yes- (24 Hr on/off - 1 minute Increments up to 24 Hrs)	Yes- (24 Hr on/off - 1 minute Increments up to 24 Hrs)
Clock		YES (on the remote controller)	YES (on the remote controller)	YES (on the remote controller)	YES (on the remote controller)
Air Swing (Motorized - Upward & Downward Motion)		Yes	Yes	Yes	Yes
Auto-Restart		Yes	Yes	Yes	Yes
Fahrenheit to Celsius function		Yes	Yes	Yes	Yes
<b>Dimensions</b>					
Net Dimensions - Indoor Unit	(mm) WxHxD	430x690x325	442x750x382	442x750x382	442x750x382
Net Weight - Indoor Unit	(kg)	25,5	26	34	35
Packing Dimensions - Indoor Unit	(mm) WxHxD	480x880x380	500x890x425	500x890x425	500x890x425
Gross Weight - Indoor Unit	(kg)	29,5	30	38,5	39,5
Loading Capacity (20'/40'/40'HC)		146/302/447	118/248/375	118/248/375	118/248/375
<b>Unit Accessories</b>					
Flexible Condenser Air Hose (included)		Yes (1 - 6.3" Dia X 59"Length) (White 800043)	Yes (1 - 6.3" Dia X 59"Length) (White 800043)	Yes (1 - 6.3" Dia X 59"Length) (White 800043)	Yes (1 - 6.3" Dia X 59"Length) (White 800043)
Window/Product Exhaust Adapters (2) - Included		Yes	Yes	Yes	Yes
Window Exhaust Adapter Rain Guard Cover (1) - included		Yes	Yes	Yes	Yes
Additional Water tank		NO	NO	NO	NO

# Portable – V series

R290



Smart Mode

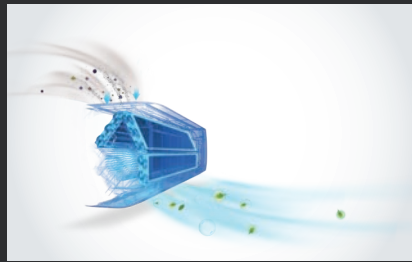

Anti-bacterial fin



Window kit



Anti-bacteria Fin



I Feel



Smart Mode



Comfortable Sleep



Dehumidify



Quiet Mode



Timer 24 h



Fast Cooling



User Friendly Control & Display



Display Friendly



Remote Control



Window kit



Self-diagnosis



New gas  
NO F-Gas Cost



4 Casters for  
Easy Moving



Model		VAPC07	VAPC09
Model Code		20009657	20009658
Type		T1, Cooling Only	T1, Cooling Only
<b>Ratings</b>			
Cooling Capacity	W	2050	2490
Heating Capacity	W	-	-
Moisture Removal	L/H.r	0.8	0.9
Air Circulation (H/L)	m <sup>3</sup> /h	290/230	320/260
EER for Cooling	W/W	2,61	2,62
COP for Cooling	W/W	-	-
Energy Class	Cooling	A	A
Refrigerant		R290	R290
Refrigerant charge volume	g	150	170
Indoor Unit Noise Level (Sound Pressure)	High (dB (A))	51	52
	Mid (dB (A))	50	50
	Low (dB (A))	48	48
Indoor Unit Noise Level (Sound Power)	High (dB (A))	63	65
<b>Power Supply</b>			
Voltage, Frequency, Phase	V	220~240V~, 50Hz, 1P	220~240V~, 50Hz, 1P
Rated Current	Cooling (A)	3,5	4,5
	Heating (A)	/	/
<b>Features</b>			
Display Type		LED	LED
Sleep Mode		Yes (on the controller)	Yes (on the controller)
Dry Mode (auto speed only)		Yes	Yes
Water Full Indicator		Yes	Yes
Auto Cool (auto fan in cooling)		Yes (on the controller)	Yes (on the controller)
Smart Mode (remote access)		Yes (on the controller)	Yes (on the controller)
Rapid Cool(Jet) Mode (lowest temp & high speed) - remote only		NO	NO
Fan Only		Yes - 3 Speed	Yes - 3 Speed
Anion		No	No
Cooling Speed Selections		2	2
Timer- (24 Hr On/Off)		Yes- (24 Hr on/off 1 minute Increments up to 24 Hrs)	Yes- (24 Hr on/off 1 minute Increments up to 24 Hrs)
Clock		YES (on the remote controller)	YES (on the remote controller)
Air Swing (Motorized - Upward & Downward Motion)		No	No
Auto-Restart		Yes	Yes
Fahrenheit to Celsius function		Yes	Yes
<b>Dimensions</b>			
Net Dimensions - Indoor Unit	(mm) WxHxD	300x330x670	300x330x670
Net Weight - Indoor Unit	(kg)	21	24,5
Packing Dimensions - Indoor Unit	(mm) WxHxD	340x385x880	340x385x880
Gross Weight - Indoor Unit	(kg)	25	28,5
Loading Capacity (20'/40'/40'HC)		204/420/615	204/420/615
<b>Unit Accessories</b>			
Flexible Condenser Air Hose (included)		Yes (1 - 5.1" Dia X 59" Length) (grey)	Yes (1 - 5.1" Dia X 59" Length) (grey)
Window/Product Exhaust Adapters (2) - Included		Yes	Yes
Window Exhaust Adapter Rain Guard Cover (1) - included		NO	NO
Additional Water tank		NO	NO

# Technical specifications

Series Name	Silentium Pro	Fresh Master	Energy Pro Plus	Energy Pro	Energy SE	Apple Pie Pro
<b>Comfortable</b>						
Multi Dimension Airflow	•	—	—	—	—	—
Verticle&Horizontal auto-swing	—	•	•	•	•	•
Sleep Mode	4	4	4	4	1	1
Fast Cooling/Heating	•	•	•	•	•	•
Quiet mode (Sound pressure)	16dB(A)	18dB(A)	18dB(A)	18dB(A)	19dB(A)	19dB(A)
I feel	•	•	•	•	•	•
<b>Convenient</b>						
Dual Self-cleaning (Indoor+Outdoor units)	•	•	•	•	—	—
Self-Cleaning (Indoor unit)	—	—	—	—	•	•
Mildew-proof	•	•	•	•	•	•
8 °C Heating	•	•	•	•	•	•
timer 24h	•	•	•	•	•	•
Dimmer	•	•	•	•	•	•
Easy installation	—	—	—	—	—	—
Easy maintenance	—	—	—	—	•	•
Service checker	•	•	•	•	•	•
LCAC Wired controller (multi split)	•	•	•	•	•	•
Dual Drainage	—	—	•	•	•	•
<b>Health</b>						
Hi-NA— 2021 new feature	•	•	•	•	•	•
Cold plasma Generator	—	—	—	—	—	—
Fresh Air	—	•	—	—	—	—
Air Quality Indicator	—	•	—	—	—	—
4 in 1 filter: vitamine C + catechin + sliver + HEPA	—	•	•	•	•	•
4 in 1 filter: aroma + sliver, Catechin + Hepa	—	—	—	—	—	—
Filter of carbon	—	•	•	•	•** *Only models KA50K/KA70	•
Silver ion filter	—	—	—	—	—	—
<b>Intelligent</b>						
Wifi Fuction	•	•	•	•	•	•
Smart Voice Control	•	•	•	•	•	•
Smart Eye	•	—	•	—	—	—
TMS Comfort Control System	•	—	•	—	—	—
AI SMART	•	—	•	—	—	—
SMART MODE	•	•	•	•	•	•
<b>Reliability</b>						
Multi Anti-corrosion Treatment	•	•	•	•	•	•
Self-diag—sis Protection	•	•	•	•	•	•
Anti-bacteria fin	•	•	•	•	•	•
<b>Tech—logy</b>						
On/off function, room card/fire alarm	•	•	•	•	•	•
Outdoor unit chassis heating	•	•	•	•	•	•
360 Full DC inverter (DC compressor+ 2 DC fan motors)	•	•	•	•	•	—
Electronic expansion valve	•	•	•	•	•	—
Universal unit(for indoor)	•	—	•	•	•	•
Heating low to Temp	-22°C	-22°C	-22°C	-22°C	-22°C	-20°C
1W Standby	1W	1W	1W	1W	1W	1W

- YES
- NO





A modern, two-story house with a white facade and large glass windows and balconies. The interior lights are on, and the house is illuminated from within. A swimming pool is visible in the foreground, reflecting the house and the sky. The sky is a deep blue, suggesting dusk or dawn. The overall scene is a high-quality architectural rendering.

# 03 | MULTISPLIT FREEMATCH

# Freematch



Compact Design



Up To 5



Big Family



New Path Design



## Outstanding construction with different installation options

### Compact Design

Lighter and more compact units for easy installation, flexible installation location, larger packing volume and various transportation.

Note: Hisense has the most compact 1 by 2 multi-split outdoor unit model in class.

## Individually controlled indoor units all connected to one outdoor unit

### Freematch Up To 5

One Freematch outdoor unit can be matched with up to 5 different types of indoor unit and each indoor unit can be individually controlled.

Note: Refer to the Freematch match table for more information.

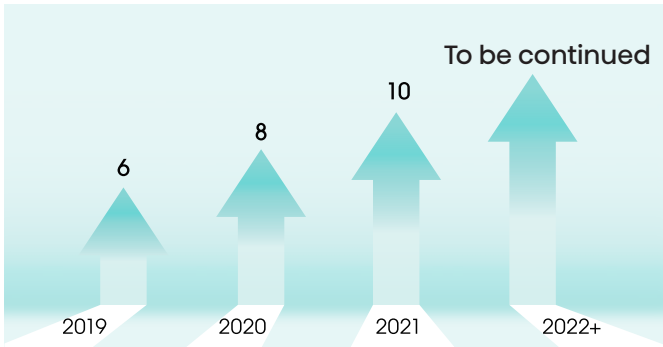

## Different expansion and upgrade options

### Big Family

We will be having 10 models of R32 Freematch on sale in 2021, which can provide customers with more choices. And this family are all DC so that they can be used in 50Hz or 60Hz countries and regions.

Capacity range: 3500W ~ 12500W

Match range: 1 by 2 ~ 1 by 5

## High efficiency and ice block prevention

### New Path Design

Reverse path design improves efficiency of exchanger greatly. At the rear of the path are super cooling paths, which can improve the cooling capacity and add the length of pipes between indoor and outdoor units. While it is running heating mode, this can prevent base pan from ice block.

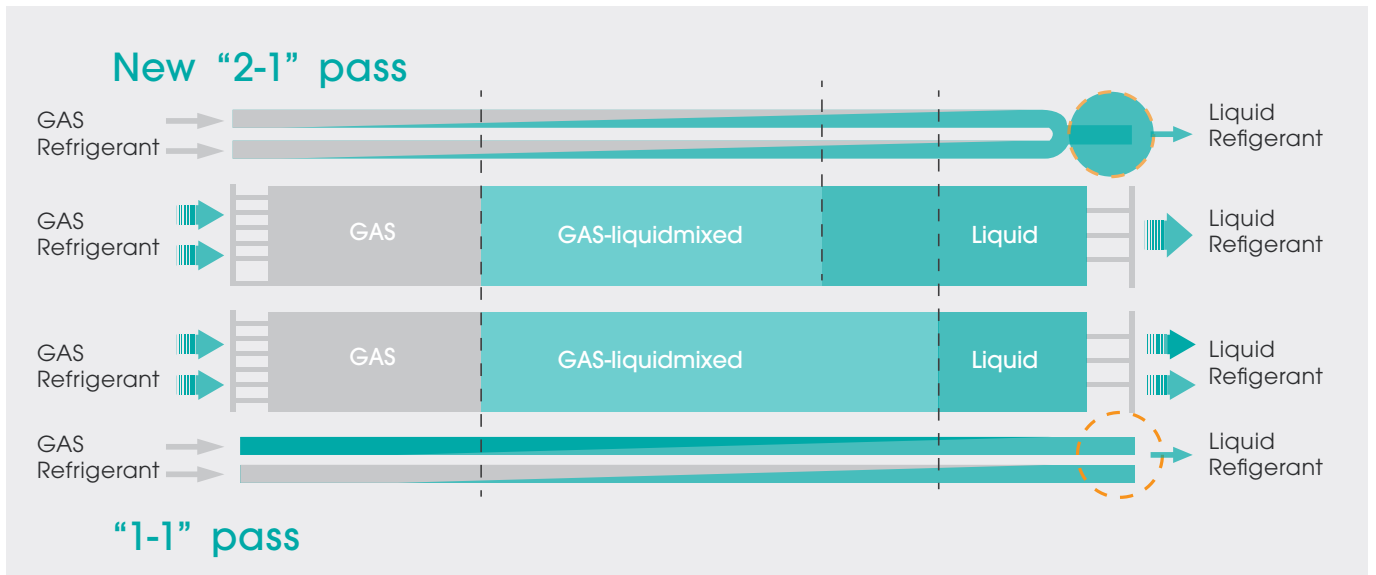





# Line up

| FM Super R32 Inverter





	Model		Up to		Power
	2AMW35U4RGC 2AMW42U4RGC 2AMW52U4RXC	→	2	→	3.5kW, 4.1kW, 5.0kW
	3AMW52U4RJA 3AMW62U4RJC 3AMW72U4RJC	→	3	→	5.5kW, 6.3kW, 7.0kW
	4AMW81U4RAA 4AMW105U4RAA	→	4	→	8.0kW, 10.0kW
	5AMW125U4RTA	→	5	→	12.5kW

## Technical specifications

# Freematch ODU



# FM Super R32 Inverter

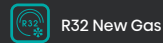

R32 New Gas

Leakage  
Detective

Pump Down

Cooling at  
-15°C (5°F)Low Temperature  
Heating

Easy Installation

Intelligent  
Defrost

Spacing Saving



Service Checker

Model		2AMW35U4RGC	2AMW42U4RGC	2AMW52U4RXC	3AMW52U4RJA	3AMW62U4RJC
Matching Indoor Units		Up to 2	Up to 2	Up to 2	Up to 3	Up to 3
Nominal Cooling	W	3500	4100	5000	5500	6300
Nominal Heating	W	3500	3500	4500	6300	5000
SEER	W / W	8,10	8,00	7,60	7,30	8,00
SCOP	W / W	4,40	4,40	4,40	4,05	4,40
Energy Efficiency Class / Cooling		A++ (New ERP B)	A++ (New ERP B)	A++ (New ERP B)	A++	A++ (New ERP B)
Energy Efficiency Class / Heating		A+ (New ERP B)	A+ (New ERP B)	A+ (New ERP B)	A+	A+ (New ERP B)
EER	W / W	4,55	4,46	4,02	4,23	4,29
COP	W / W	4,82	4,74	4,23	3,94	4,43
Outdoor Unit (W x H x D)	mm	715×540×240	715×540×240	810×580×280	860 × 670 × 310	860×670×310
Diameter (Liquid)	mm	6.35×2	6.35×2	6.35×2	6.35 × 3	6.35×3
Diameter (Gas)	mm	9.52×2	9.52×2	9.52×2	9.52 × 3	9.52×3
Power Supply	Outdoor Source	220-240/50&60/1~	220-240/50&60/1~	220-240/50&60/1~	220-240V~50/60Hz	220-240/50&60/1~
	Source	Outdoor Supply	Outdoor Supply	Outdoor Supply	Outdoor Supply	Outdoor Supply

Model		3AMW72U4RJC	4AMW81U4RAA	4AMW105U4RAA	5AMW125U4RTA
Matching Indoor Units		Up to 3	Up to 4	Up to 4	Up to 5
Nominal Cooling	W	7000	8000	10000	12500
Nominal Heating	W	5000	9000	11000	13500
SEER	W / W	7,90	7,01	6,50	-
SCOP	W / W	4,40	4,05	4,01	-
Energy Efficiency Class / Cooling		A++ (New ERP B)	A++	A++	-
Energy Efficiency Class / Heating		A+ (New ERP B)	A+	A+	-
EER	W / W	4,00	3,56	3,23	3,46
COP	W / W	4,00	4,00	3,93	3,56
Outdoor Unit (W x H x D)	mm	860×670×310	950 × 840 × 340	950 × 840 × 340	950 × 1050 × 340
Diameter (Liquid)	mm	6.35×3	6.35 × 4	6.35 × 4	6.35 × 5
Diameter (Gas)	mm	9.52×3	9.52 × 4	9.52 × 4	9.52 × 5
Power Supply	Outdoor Source	220-240/50&60/1~	220-240V~50/60Hz	220-240V~50/60Hz	220-240V~50/60Hz
	Source	Outdoor Supply	Outdoor Supply	Outdoor Supply	Outdoor Supply

# RAC IDU

## FM Super R32 Inverter

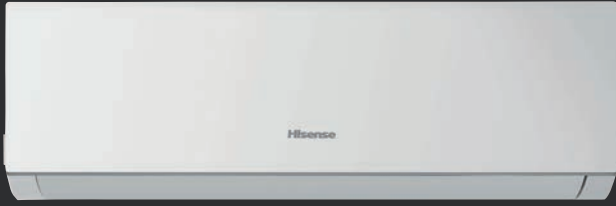



 WiFi Control

 ON/ OFF Function

 Room Card Control

 Fire Leakage Control

 Vertical Auto Swing

 Horizontal Auto Swing

 Dimmer

 Self-diagnosis Protection

 Universal Unit



### Energy Pro

Model Name		QE25XV0EG	QE35XV0EG
Cooling capacity	W	2600	3500
Heating capacity	W	3200	4200
Power input (Indoor Unit Only)	W	26	30
Rated current (Indoor Unit Only)	A	0,13	0,15
Air flow	m <sup>3</sup> /h	600	650
Noise Level (Sound Power)	dB(A)	55	55
Net Dimension - Indoor Unit (WxHxD)	mm	835×305×198	835×305×198
Net Weight - Indoor Unit	kg	10	10
Diameter (Liquid)	mm	6,35	6,35
Diameter (Gas)	mm	9,52	9,52



### Energy Pro Plus

Model Name		QG25XV0EG	QG35XV0EG
Cooling capacity	W	2600	3500
Heating capacity	W	3200	4200
Power input (Indoor Unit Only)	W	26	30
Rated current (Indoor Unit Only)	A	0,13	0,15
Air flow	m <sup>3</sup> /h	600	650
Noise Level (Sound Power)	dB(A)	55	55
Net Dimension - Indoor Unit (WxHxD)	mm	835×305×198	835×305×198
Net Weight - Indoor Unit	kg	10	10
Diameter (Liquid)	mm	6,35	6,35
Diameter (Gas)	mm	9,52	9,52

## Technical specifications

### RAC IDU

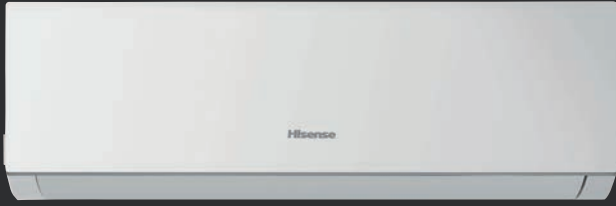

### FM Super R32 Inverter

 WiFi Control

 ON/ OFF Function

 Room Card Control

 Fire Leakage Control

 Vertical Auto Swing

 Horizontal Auto Swing

 Dimmer

 Self-diagnosis Protection

 Universal Unit



### Energy SE

Model Name		KA25MR0EG	KA35XR0EG	KA50BS0EG	KA70KT0EG
Cooling capacity	W	2600	3500	5000	7000
Heating capacity	W	3000	3900	5400	7500
Power input (Indoor Unit Only)	W	22	24	45	52
Rated current (Indoor Unit Only)	A	0,3	0,3	0,4	0,5
Air flow	m <sup>3</sup> /h	520	580	950	1100
Noise Level (Sound Power)	dB(A)	56	56	60	63
Net Dimension - Indoor Unit (WxHxD)	mm	822×258×203	822×258×203	920×321×227	1008×325×217
Net Weight - Indoor Unit	kg	7,7	7,8	11	12
Diameter (Liquid)	mm	6,35	6,35	6,35	9,52
Diameter (Gas)	mm	9,52	9,52	12,7	15,88



### Apple Pie Pro

Model Name		TG25VE0EG	TG35VE0EG	TG50XA0EG
Cooling capacity	W	2600	3500	5000
Heating capacity	W	2800	4000	5600
Power input (Indoor Unit Only)	W	45	45	70
Rated current (Indoor Unit Only)	A	0,2	0,2	0,3
Air flow	m <sup>3</sup> /h	550	600	1000
Noise Level (Sound Power)	dB(A)	56	56	60
Net Dimension - Indoor Unit (WxHxD)	mm	950×272×207	950×272×207	1050×320×235
Net Weight - Indoor Unit	kg	9	9	12
Diameter (Liquid)	mm	6,35	6,35	6,35
Diameter (Gas)	mm	9,52	9,52	12,7

# RAC IDU

# FM Super R32 Inverter

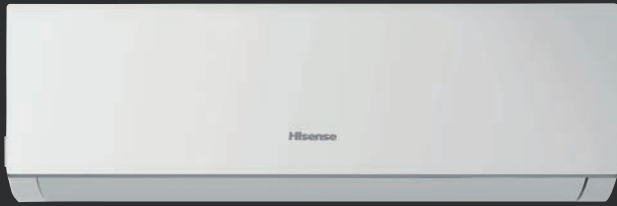



 WiFi Control

 ON/ OFF Function

 Room Card Control

 Fire Leakage Control

 Vertical Auto Swing

 Horizontal Auto Swing

 Dimmer

 Self-diagnosis Protection

 Universal Unit



## New Comfort

Model Name		DJ20YD00G	DJ25VE0BG	DJ35VE0BG	DJ50XA0BG	DJ70BB0CG
Cooling capacity	W	2100	2600	3500	5000	7000
Heating capacity	W	2500	2800	4000	5600	7100
Power input (Indoor Unit Only)	W	45	45	45	70	52
Rated current (Indoor Unit Only)	A	0,2	0,2	0,2	0,3	0,24
Air flow	m <sup>3</sup> /h	500	550	600	1000	1100
Noise Level (Sound Power)	dB(A)	56	56	56	60	63
Net Dimension - Indoor Unit (WxHxD)	mm	745×270×212	815×275×210	815×275×210	914×315×228	1085×315×228
Net Weight - Indoor Unit	kg	7,5	8,5	8,5	12	13
Diameter (Liquid)	mm	6,35	6,35	6,35	6,35	9,52
Diameter (Gas)	mm	9,52	9,52	9,52	12,7	15,88



## Mini Apple Pie

Model Name		TG20YD00G	TG25VE0BG	TG35VE0BG	TG50XA0BG	TG70BB0CG
Cooling capacity	W	2100	2600	3500	5000	7000
Heating capacity	W	2500	2800	4000	5600	7100
Power input (Indoor Unit Only)	W	43	45	45	70	52
Rated current (Indoor Unit Only)	A	0,2	0,2	0,2	0,3	0,24
Air flow	m <sup>3</sup> /h	500	550	600	1000	1100
Noise Level (Sound Power)	dB(A)	56	56	56	60	63
Net Dimension - Indoor Unit (WxHxD)	mm	880×275×207	950×272×207	950×272×207	1050×320×235	1219×320×235
Net Weight - Indoor Unit	kg	8	9	9	12	13
Diameter (Liquid)	mm	6,35	6,35	6,35	6,35	9,52
Diameter (Gas)	mm	9,52	9,52	9,52	12,7	15,88

## Technical specifications

# Cassette IDU



WiFi Easy



ON/OFF Function

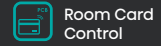

Room Card Control

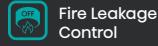

Fire Leakage Control



Vertical Auto Swing



High Ceiling



Fresh Air Intake



Silver Ion Filter



Universal Unit

Model Name		ACT26UR4RCA4	ACT35UR4RCA4	ACT52UR4RCA4
Nominal Cooling	W	2840	3750	5200
Nominal Heating	W	3130	4000	5900
Input-Cooling	W	22	35	41
Input-Heating	W	22	35	41
Air Circulation	m <sup>3</sup> / h	500	600	700
Sound Pressure (H / M / L)	dB (A)	33/ 30/ 27	35/ 32/ 29	37/ 34/ 30
Net Dimension (W x H x D)	mm	570 × 215 × 570	570 × 215 × 570	570 × 215 × 570
Net Weight	kg	15	15	16
Package Dimension (W x H x D)	mm	730 × 668 × 292	730 × 668 × 292	730 × 668 × 292
Gross Weight	kg	18	18	19
Liquid Pipe	mm	6.35	6.35	6.35
Gas Pipe	mm	9.52	9.52	12.7
Power Supply	Indoor	220-240V-50/60Hz	220-240V-50/60Hz	220-240V-50/60Hz
	Source	Outdoor Supply	Outdoor Supply	Outdoor Supply

# Duct IDU

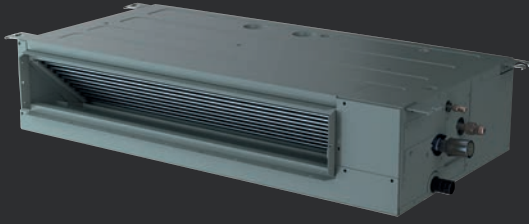



## FM Super R32 Inverter

 WiFi Control

 ON/ OFF Function

 Room Card Control

 Fire Leakage Control

 Water Level Switch

 Built-in Drain Pump

 Slim Design

 Filter Clean Signal

 Universal Unit

Model Name		ADT26UX4RBL4	ADT35UX4RBL4	ADT52UX4RCL4
Nominal Cooling	W	2900	3520	5300
Nominal Heating	W	3100	3800	5800
Input-Cooling	W	22	25	32
Input-Heating	W	22	25	32
Air Circulation	m <sup>3</sup> / h	520	600	900
Sound Pressure (H / M / L)	dB (A)	32/ 29/ 27	36/ 33/ 30	41/ 37/ 33
Net Dimension (W x H x D)	mm	910 × 190 × 445	910 × 190 × 447	1180 × 190 × 445
Net Weight	kg	18	18	30
Package Dimension (W x H x D)	mm	1080 × 285 × 565	1080 × 285 × 565	1350 × 285 × 565
Gross Weight	kg	21.5	21.5	35
Liquid Pipe	mm	6.35	6.35	6.35
Gas Pipe	mm	9.52	9.52	12.7
Power Supply	Indoor	220-240V-50/60Hz	220-240V-50/60Hz	220-240V-50/60Hz
	Source	Outdoor Supply	Outdoor Supply	Outdoor Supply

## Technical specifications

# Ceiling & Floor IDU Console IDU



 WiFi Control

 ON/OFF Function

 Room Card Control

 Fire Leakage Control

 Slim Design

 Universal Unit



## FM Super R32 Inverter

Model Name		AKT26UR4RK4	AKT35UR4RK4	AKT52UR4RK4	AVT52UR4RA4
Nominal Cooling	W	2950	3520	5000	5280
Nominal Heating	W	3050	3800	5100	5600
Input-Cooling	W	22	25	35	38
Input-Heating	W	22	25	35	38
Air Circulation	m <sup>3</sup> / h	520	600	700	800
Sound Pressure (H / M / L)	dB (A)	39/ 33/ 28	38/ 35/ 33	44/ 40/ 35	41/ 37/ 34
Net Dimension (W x H x D)	mm	700 × 630 × 220	700 × 630 × 220	700 × 630 × 220	990 × 230 × 680
Net Weight	kg	15	15	15	29
Package Dimension (W x H x D)	mm	840 × 730 × 340	840 × 730 × 340	840 × 730 × 340	1100 × 350 × 820
Gross Weight	kg	19	19	19	34
Liquid Pipe	mm	6.35	6.35	6.35	6.35
Gas Pipe	mm	9.52	9.52	9.52	12.7
Power Supply	Indoor	220-240V-50/60Hz	220-240V-50/60Hz	220-240V-50/60Hz	220-240V-50/60Hz
	Source	Outdoor Supply	Outdoor Supply	Outdoor Supply	Outdoor Supply



# Installation Drawings

2AMW35U4RGC  
2AMW42U4RGC

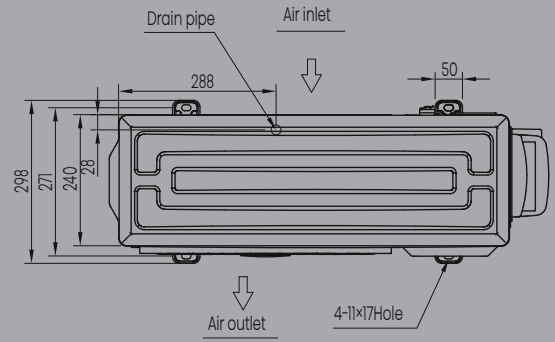
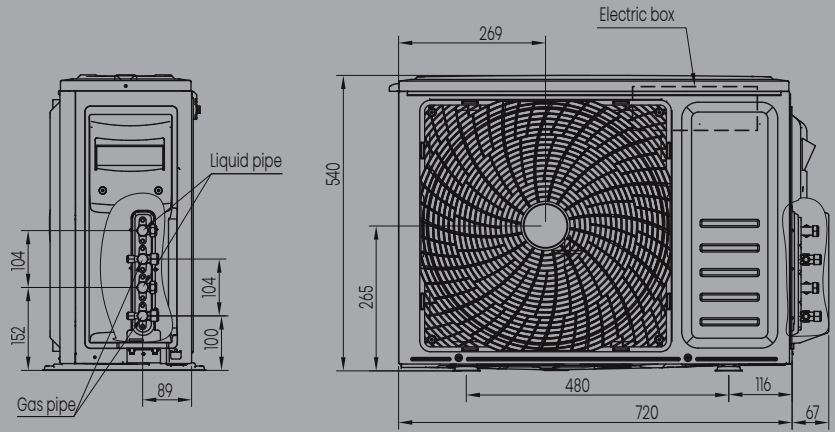

2AMW52U4RXC

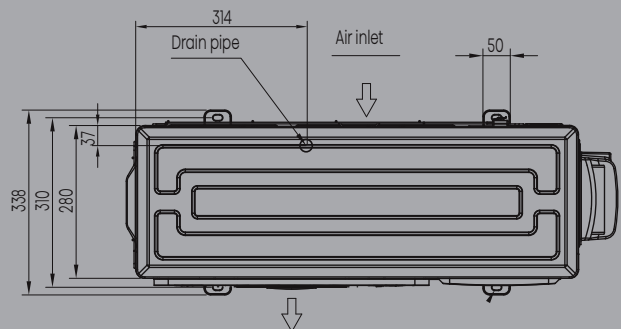
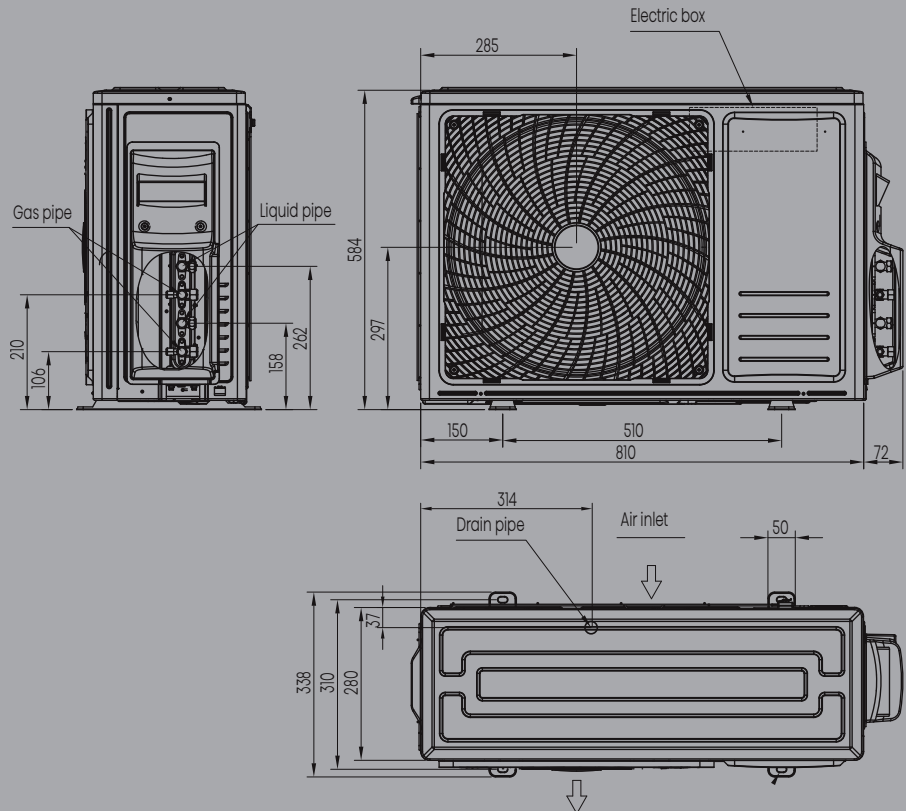

# Installation Drawings

3AMW42U4RJA

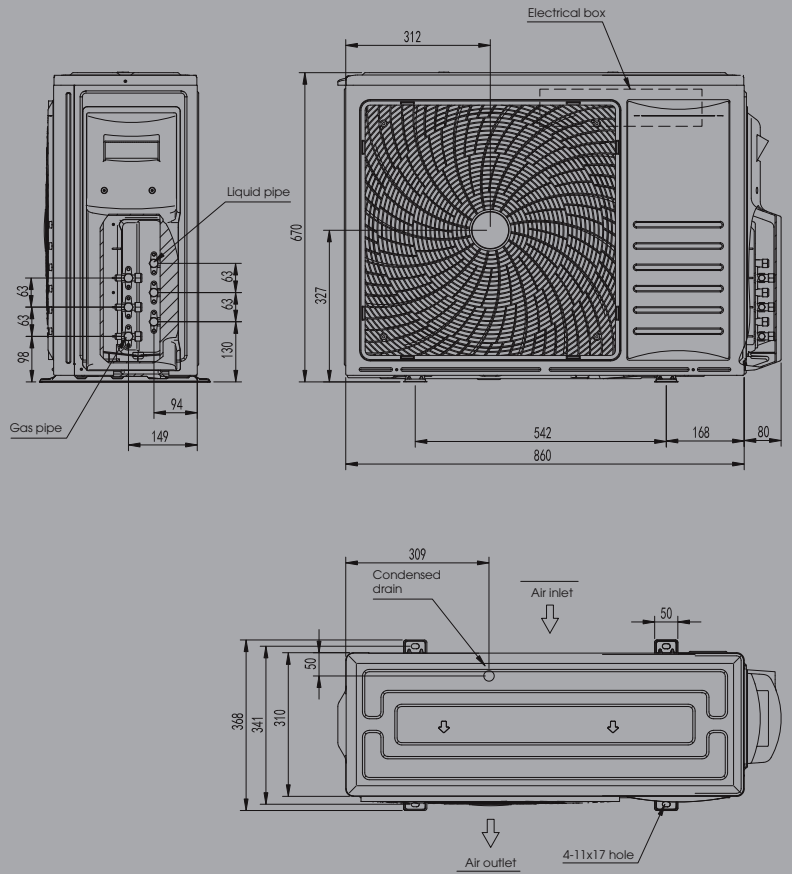

3AMW62U4RJC

3AMW72U4RJC

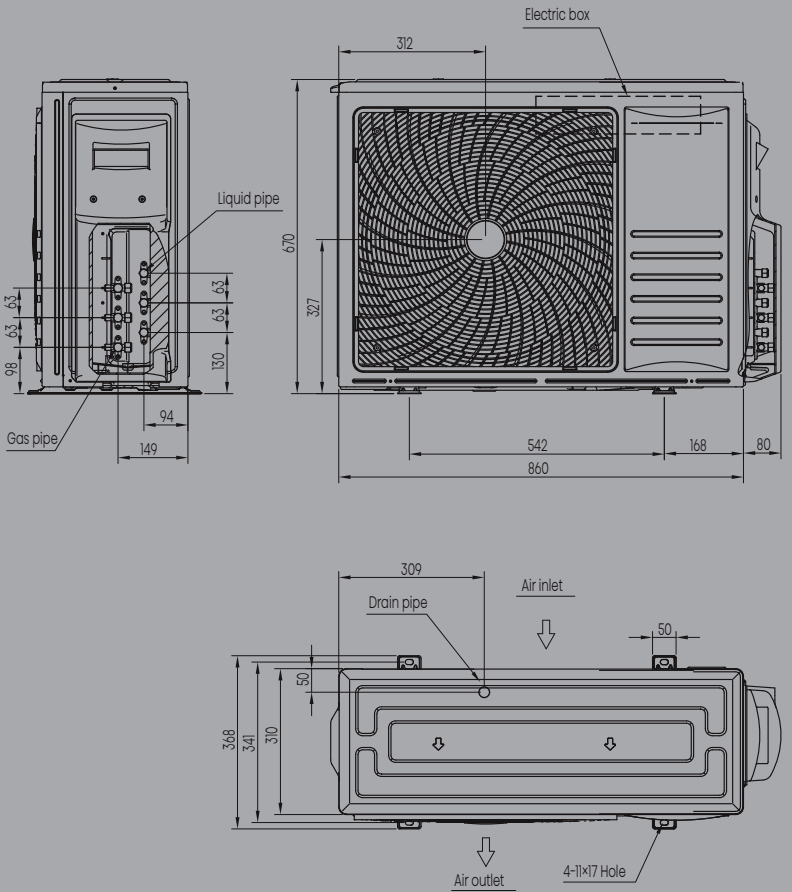

4AMW81U4RAA  
 4AMW105U4RAA

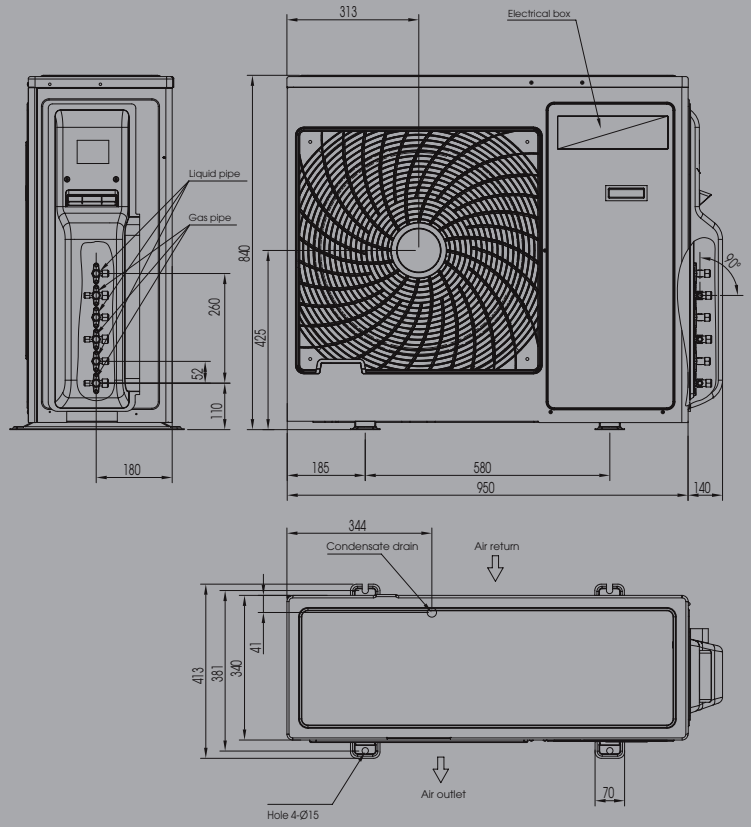

5AMW125U4RTA

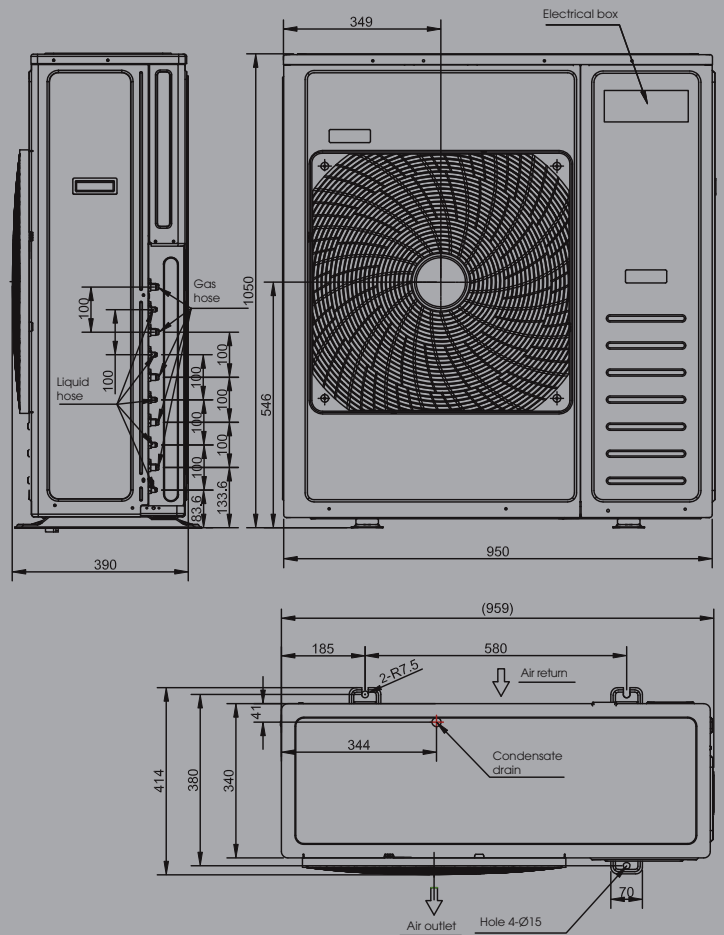





**04** | LIGHT  
**COMMERCIAL**

# Cassette



Compact Design



Round Flow



Fresh Air Intake



High Ceiling

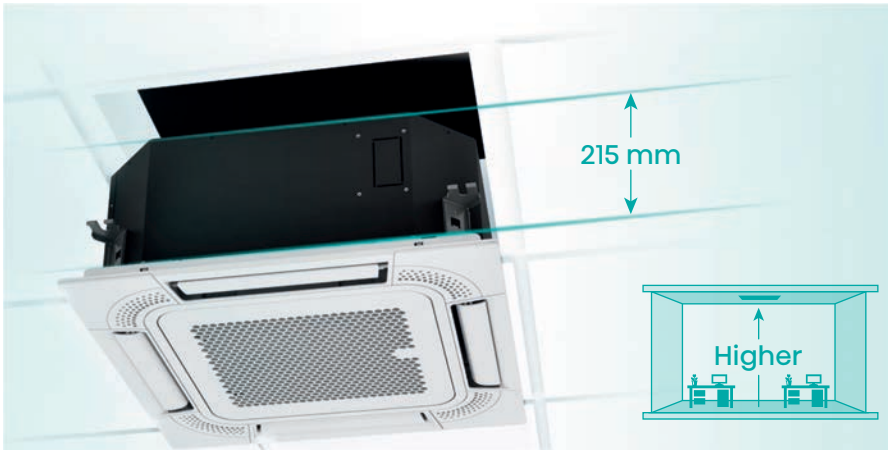

## Keep your room spacious

### Compact Design

The compact design with the body thickness of only 215mm and the installation thickness of 245mm reduces the ceiling height. The compact design makes the slimmest design in class.

## Next level experience

### Round Flow

360°Round Flow can give optimum efficiency and comfort. Full-flat panel and micro-channel design allow smooth air supply and ensure the best comfort.

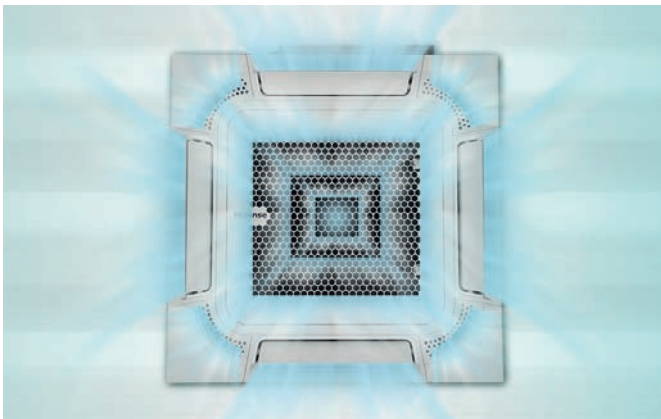

## Easily adjusted to your wishes and needs

### High Ceiling

When the ceiling is high, the unit parameters can be set through the wired controller to compensate the installation height, so that the cool air can blow down to people's activity area.

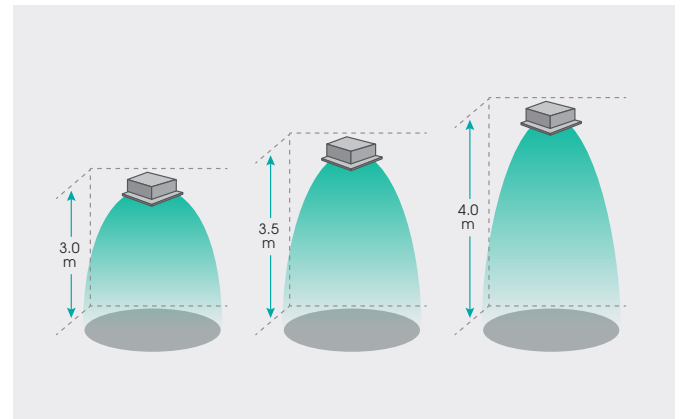

## Outdoor freshness in the comfort of your home

### Fresh Air Intake

The function of Fresh Air Intake will introduce the outdoor fresh air into the room to improve indoor air quality.

Note: The proportion of fresh air volume cannot exceed 20% of the total design air volume.

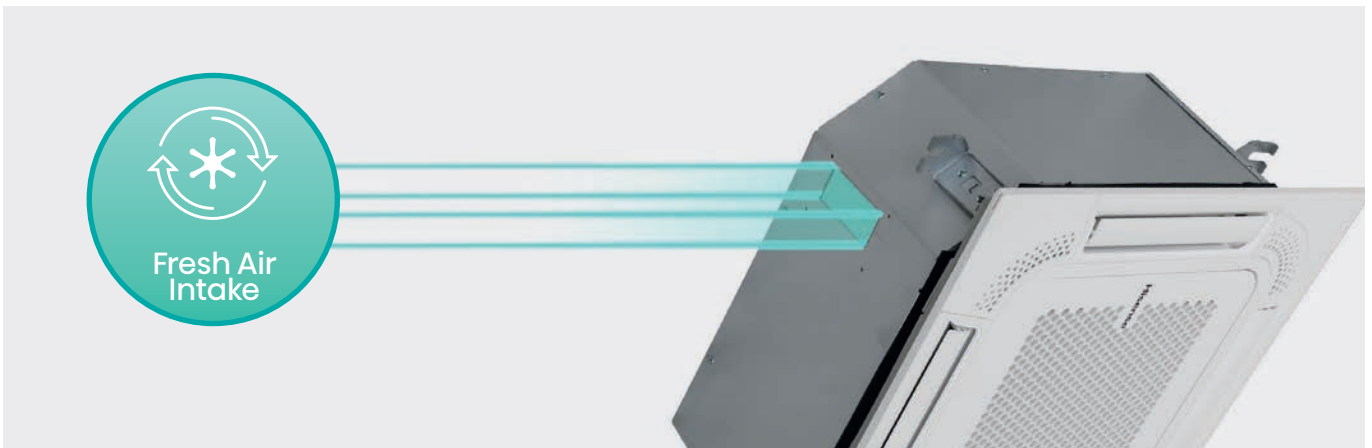

# Duct



Slim Design



Flexible Installation



1 Pa ESP Setting



150Pa MSP Duct



## Great for all types of places

### Slim Design

The slim duct unit, with a thickness of only 190mm, makes it no longer a challenge to narrow ceiling voids. The external static pressure of up to 50Pa facilitates unit use with flexible ducts of varying lengths.

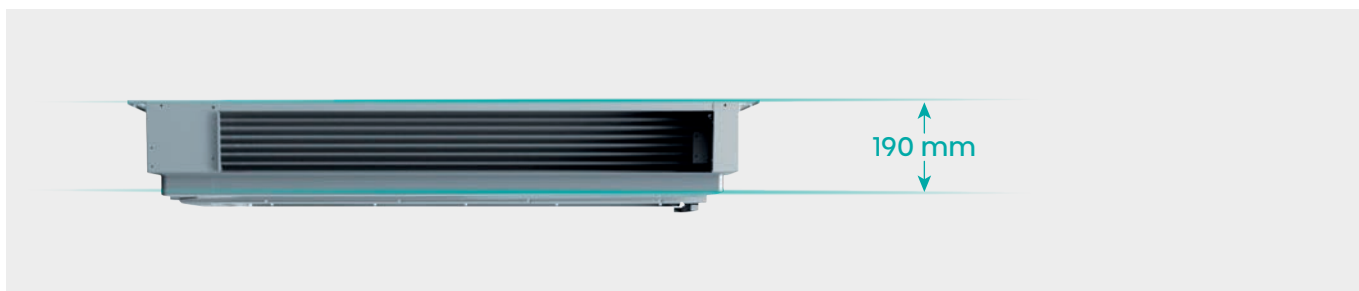

## Different air suction options

### Flexible Installation

Air suction direction can be altered from rear to bottom suction, giving a choice between free use and connection to optional suction grilles.

Note: The rear suction is 5dB lower than the bottom suction, so it is recommended to use the rear suction.

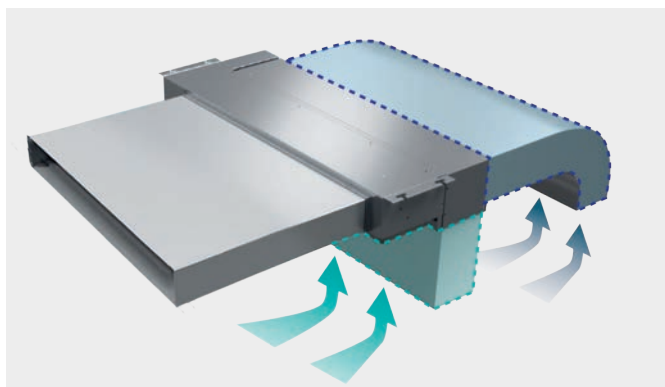

## Highly accurate flow remote control

### 1 Pa ESP Setting

Possibility to change ESP via wired remote controller allows optimisation of the supply air volume. And the adjust precision of 1 Pa can give the most accurate ESP setting in class.

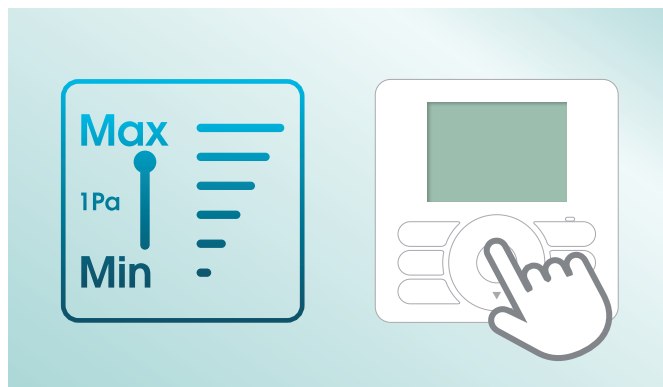

## Excellent choice for different types of buildings

### 150Pa MSP Duct

The external static pressure of MSP Duct unit up to a maximum of 150Pa makes units applicable for a wide range of building types.

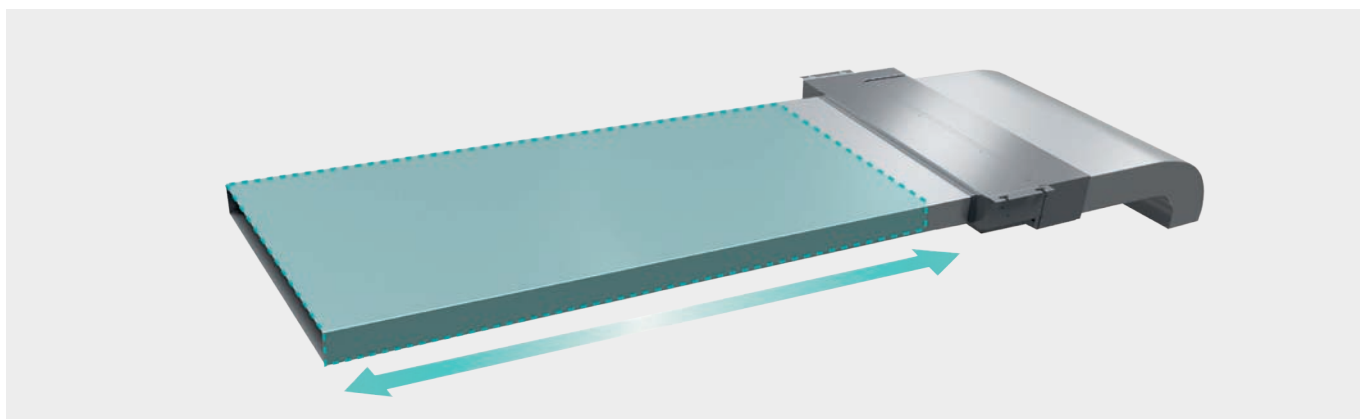

# Ceiling & Floor



Several  
Installation Modes



4D Airflow



WiFi Easy



High Ceiling

## Positioned so it suits you best

### Several Installation Modes

Ceiling & Floor unit adopts a special structure which can meet seat, lifting and inclined installation mode. What's more, piping can be arranged in four directions, left, right, rear, and bottom.

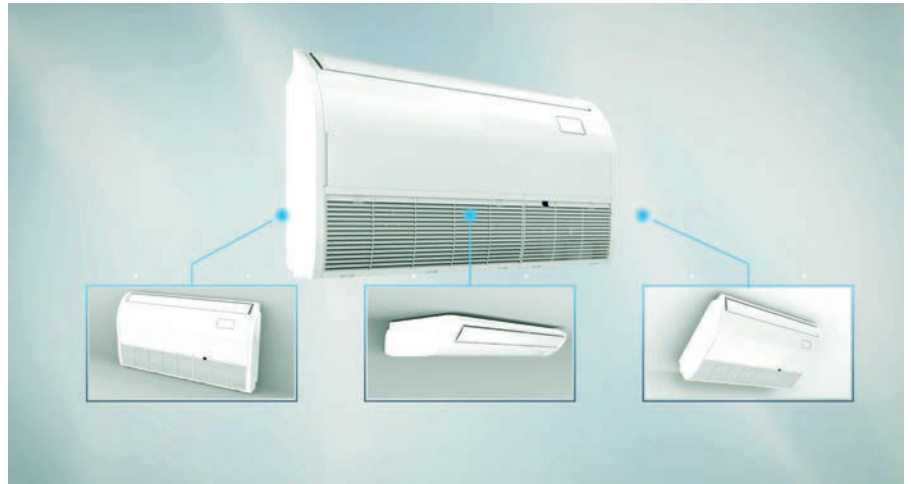

## Comfortable air flow even in wide rooms

### 4D Airflow

The horizontal and vertical air flow swings can provide better room comfort. Ideal for comfortable air flow in wide rooms:

- up to 90° discharge horizontal angle
- up to 65° discharge vertical angle



## Easy wifi handling

### WiFi Easy

WiFi module can be fixed easily in multiple optional positions of the indoor unit with 3M double-sided tape. The installer can flexibly determine the installation location of the WiFi module according to the strength of the WiFi signal.



## Easily adjusted to your wishes and needs

### High Ceiling

When the ceiling is high, the unit parameters can be set through the wired controller to compensate the installation height, so that the cool air can blow down to people's activity area.

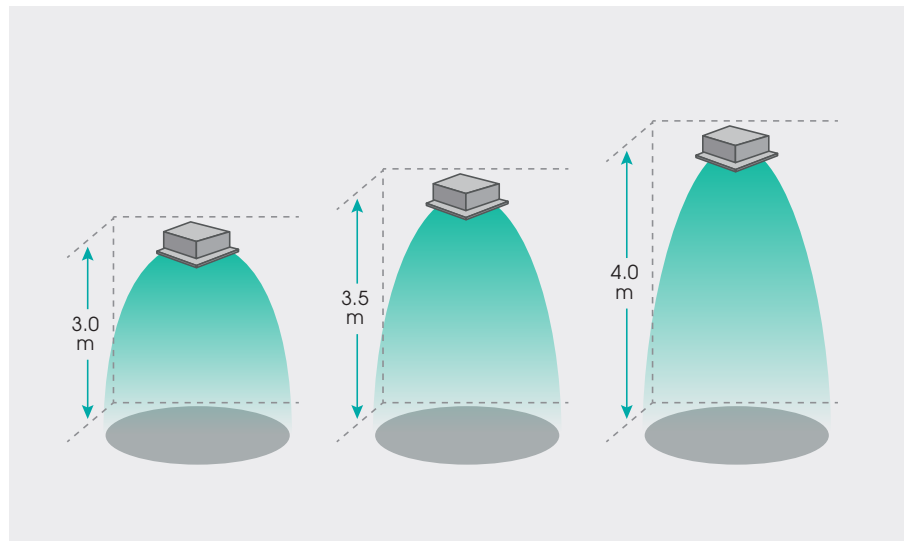

# Console



Several  
Airflow Modes



Independent  
Dual Vane



LED  
Display



Effective  
Heating

## Different air distribution options

### Several Airflow Modes

Various air-out combinations of top air-out, bottom air-out and top-bottom make the room air distribution and temperature more comfortable.

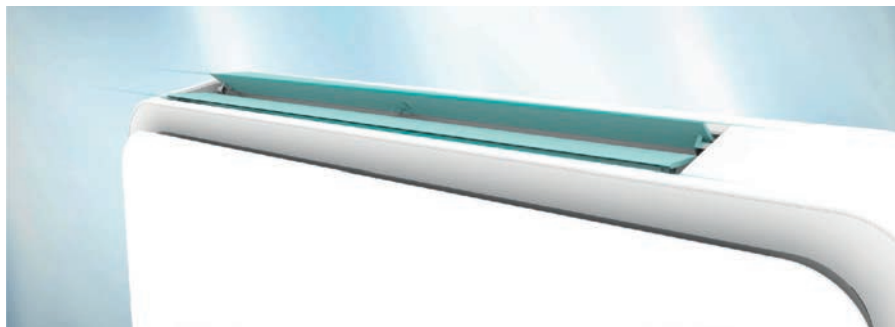

### Better air and comfort delivery

#### Independent Dual Vane

The unique dual vane can be completely sealed when the unit is off, and can rotate independently when the unit is on. So the console unit can give a more comfortable airflow distribution.

### Discrete, yet easy to read

#### LED Display

The 88 LED hidden display makes the console unit simple and beautiful.



### Warmth coming from where you need it most

#### Effective Heating

The hot airflow blowing from the bottom air-out can give an effective heating, namely Foot Warming Effect.

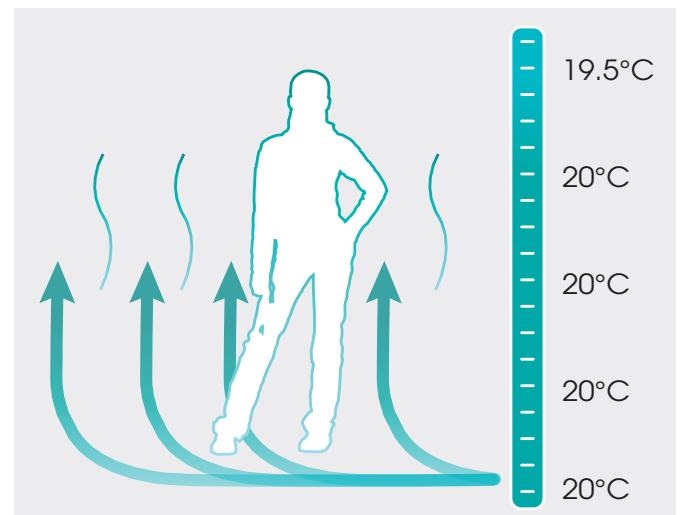

# LCAC ODU



Twin, Triple  
and Quadruple



Wide Temperature  
Range



Leakage  
Alarm



Service  
Hi-Checker

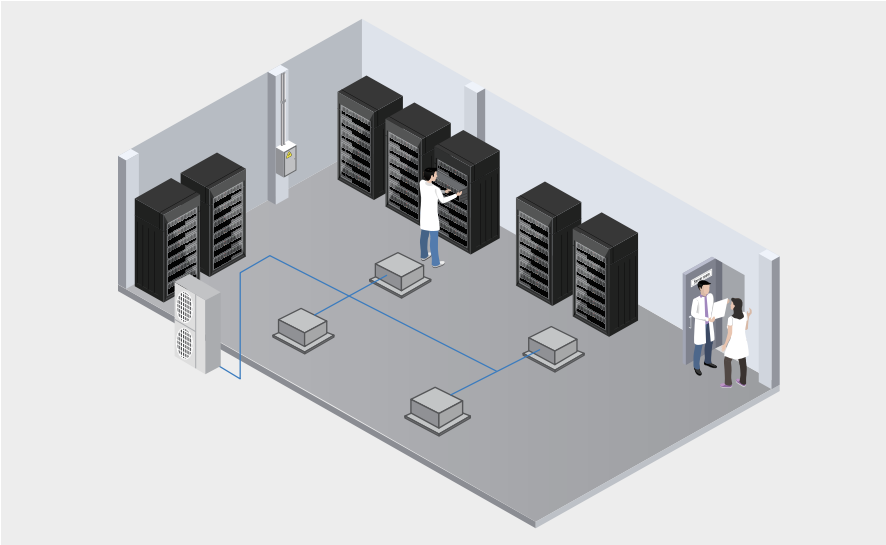

## Different units controlled through one central system

### Twin, Triple and Quadruple

With the cooperation of simplified central control system, the LCAC unit can be combined into a simplified mini VRF system. We call them twin, triple and quadruple system.

Note: All indoor units will operate at exactly the same setting in this simplified mini VRF system.



## Delivering high and low temperatures

### Wide Temperature Range

Cooling:  $-15\text{ }^{\circ}\text{C} \sim 48\text{ }^{\circ}\text{C}$

Heating:  $-15\text{ }^{\circ}\text{C} \sim 24\text{ }^{\circ}\text{C}$

The wide temperature range can cover most countries and regions with T1 and T2 climates.

Note: Refer to the temperature range in specs for the specific model.

## Safety components for carefree use

### Leakage Alarm

The control system will send an error alarm and stop running when the refrigerant leakage ratio reaches a certain value so as to ensure safe operation of the air conditioner, especially for R32.

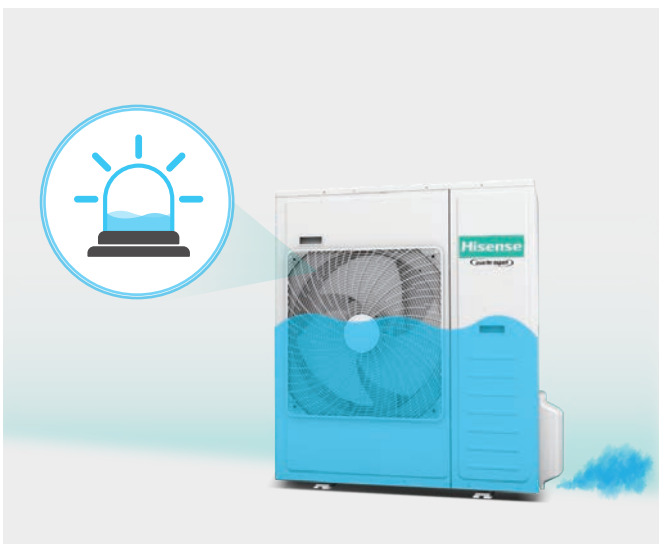

## Easy check-up and repair

### Service Hi-Checker

Hi-Checker is a software application used to record and monitor operation data of Hisense Inverter Air Conditioners. Hi-Checker can help to provide a fast, efficient and professional after-sales service.



# Line up

| Super R32 Inverter



## Indoor units

## Slim Duct



## Model

ADT26UX4RBL4  
ADT35UX4RBL4

## Power

→ 2.5kW, 3.5kW

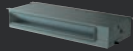

ADT52UX4RCL4  
AUD71UX4RCL4

→ 5.0kW, 7.0kW

## MSP Duct



AUD71UX4RDH4  
AUD90UX4RDH5  
AUD105UX4RDH5

→ 7.0kW, 8.5kW, 10.5kW

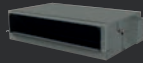

AUD125UX4RHH5  
AUD140UX4RHH5  
AUD175UX4RHH5

→ 12.5kW, 14.0kW, 17.5kW

## Compact Cassette



ACT26UR4RCA4  
ACT35UR4RCA4  
ACT52UR4RCA4

→ 2.5kW, 3.5kW, 5.0kW

## 4-Way Cassette



AUC71UR4RGB4  
AUC90UR4RGB4  
AUC105UR4RGB4  
AUC125UR4RHB4  
AUC140UR4RHB4  
AUC175UR4RHB4

→ 7.0kW, 8.5kW, 10.5kW, 12.5kW, 14.0kW, 17.5kW

## Console



AKT26UR4RK4  
AKT35UR4RK4  
AKT52UR4RK4

→ 2.5kW, 3.5kW, 5.0kW

## Ceiling &amp; Floor



AVT52UR4RA4  
AUV71UR4RA4

→ 5.0kW, 7.0kW



AUV90UR4RB4  
AUV105UR4RB4

→ 8.5kW, 10.5kW



AUV125UR4RC4  
AUV140UR4RC4  
AUV175UR4RC4

→ 12.5kW, 14.0kW, 17.5kW

Side Wind  
ODU

AUW26U4RR4  
AUW35U4RS4  
AUW52U4RS4  
AUW71U4RF4  
AUW90U4RF4

→ 2.5kW, 3.5kW, 5.0kW, 7.0kW, 8.5kW



AUW105U4RA4  
AUW125U4RT5  
AUW125U6RT4

→ 10.5kW, 12.5kW



AUW140U4RP5  
AUW140U6RP4  
AUW175U6RP4

→ 14.0kW, 17.5kW

## Technical specifications

# Compact Cassette

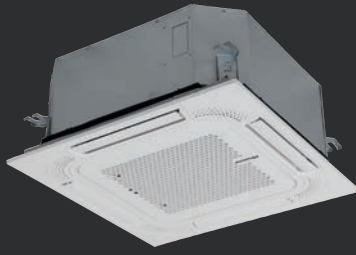

## FM Super R32 Inverter



WiFi Control

ON/OFF  
FunctionRoom Card  
ControlFire Leakage  
ControlVertical  
Auto Swing

High Ceiling



Fresh Air Intake

Silver  
Ion Filter

Universal Unit

Indoor Model		ACT26UR4RCA4	ACT35UR4RCA4	ACT52UR4RCA4
Outdoor Model		AUW26U4RR4	AUW35U4RS4	AUW52U4RS4
Nominal	W	2840	3750	5200
Nominal	W	3130	4000	5900
SEER	W / W	6.10	6.90	6.60
SCOP	W / W	4.30	4.40	4.40
Energy Efficiency Class		A++	A++	A++
Energy Efficiency Class		A+	A+	A+
Power Supply	Indoor	220-240V~50/60Hz	220-240V~50/60Hz	220-240V~50/60Hz
Power Supply	Outdoor	220-240V~50/60Hz	220-240V~50/60Hz	220-240V~50/60Hz
Indoor Unit (W × H × D)	mm	570 × 215 × 570	570 × 215 × 570	570 × 215 × 570
Outdoor Unit (W × H × D)	mm	730 × 540 × 260	810 × 580 × 280	810 × 580 × 280
IDU Qty/per 20' / 40' / 40'HQ		140 / 298 / 330	140 / 298 / 330	140 / 298 / 330
ODU Qty/per 20' / 40' / 40'HQ		136 / 284 / 284	102 / 204 / 272	102 / 204 / 272

# Installation Drawings

ACT26UR4RCA4  
 ACT35UR4RCA4  
 ACT52UR4RCA4

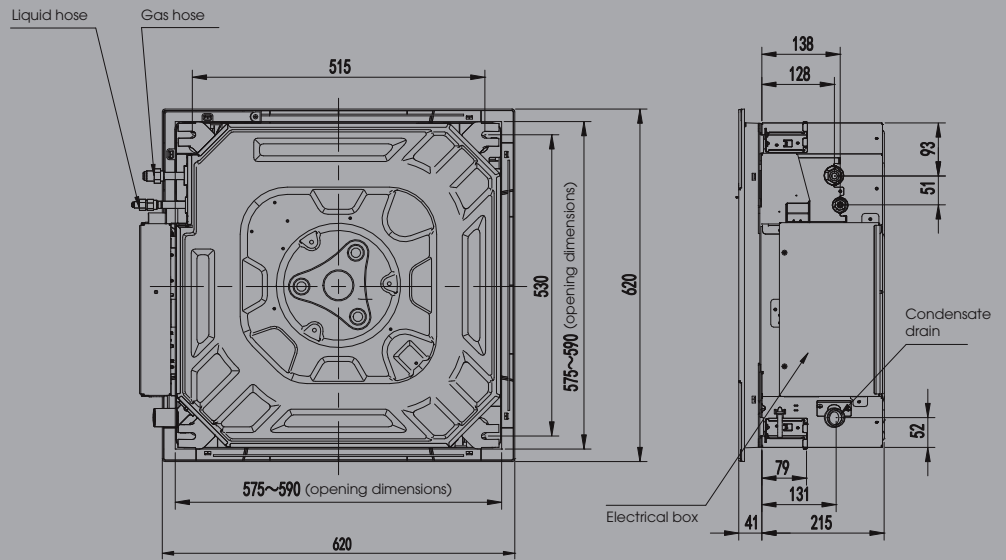
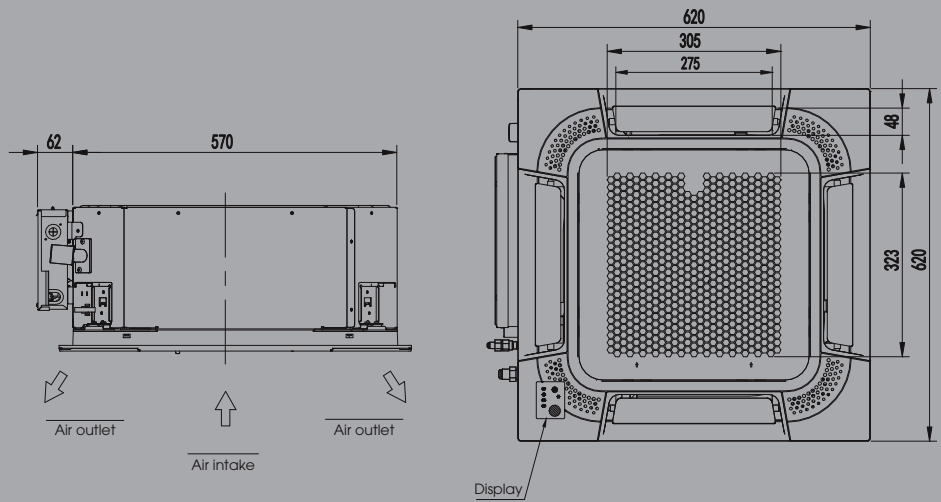

## Technical specifications

# 4-Way Cassette



## FM Super R32 Inverter

 WiFi Control

 ON/OFF Function

 Room Card Control

 Fire Leakage Control

 Vertical Auto Swing

 High Ceiling

 Fresh Air Intake

 Silver Ion Filter

 I Feel

Indoor Model		AUC71UR4RGB4	AUC90UR4RGB4	AUC105UR4RGB4	AUC125UR4RHB4
Outdoor Model		AUW71U4RF4	AUW90U4RF4	AUW105U4RA4	AUW125U6RT4
Nominal	W	7300	8800	10500	12500
Nominal	W	8300	9000	11300	13500
SEER	W / W	6.60	6.10	6.10	—
SCOP	W / W	4.40	4.20	4.00	—
Energy Efficiency Class		A++	A++	A++	—
Energy Efficiency Class		A+	A+	A+	—
Power Supply	Indoor	220-240V~50/60Hz	220-240V~50/60Hz	220-240V~50/60Hz	220-240V~50/60Hz
Power Supply	Outdoor	220-240V~ 50/ 60Hz	220-240V~50/60Hz	220-240V~50/60Hz	380-415V 3N~ 50/60Hz
Indoor Unit (W × H × D)	mm	840 × 248 × 840	840 × 248 × 840	840 × 248 × 840	840 × 298 × 840
Outdoor Unit (W × H × D)	mm	860 × 670 × 310	860 × 670 × 310	950 × 840 × 340	950 × 1050 × 340
IDU Qty/per 20' / 40' / 40'HQ		60 / 124 / 140	60 / 124 / 140	60 / 124 / 140	50 / 114 / 128
ODU Qty/per 20' / 40' / 40'HQ		90 / 186 / 186	90 / 186 / 186	52 / 106 / 106	26 / 53 / 106

Indoor Model		AUC125UR4RHB4	AUC140UR4RHB4	AUC140UR4RHB4	AUC175UR4RHB4
Outdoor Model		AUW125U4RT5	AUW140U6RP4	AUW140U4RP5	AUW175U6RP4
Nominal	W	12700	14400	14000	17200
Nominal	W	13500	17000	16800	20000
SEER	W / W	—	—	—	—
SCOP	W / W	—	—	—	—
Energy Efficiency Class		—	—	—	—
Energy Efficiency Class		—	—	—	—
Power Supply	Indoor	220-240V~50/60Hz	220-240V~50/60Hz	220-240V~50/60Hz	220-240V~50/60Hz
Power Supply	Outdoor	220-240V~50/60Hz	380-415V 3N~ 50/60Hz	220-240V~50/60Hz	380-415V 3N~ 50/60Hz
Indoor Unit (W × H × D)	mm	840 × 298 × 840	840 × 298 × 840	840 × 298 × 840	840 × 298 × 840
Outdoor Unit (W × H × D)	mm	950 × 1050 × 340	950 × 1386 × 340	950 × 1386 × 340	950 × 1386 × 340
IDU Qty/per 20' / 40' / 40'HQ		50 / 114 / 128	50 / 114 / 128	50 / 114 / 128	50 / 114 / 128
ODU Qty/per 20' / 40' / 40'HQ		26 / 53 / 106	26 / 53 / 53	26 / 53 / 53	26 / 53 / 53

# Installation Drawings

- AUC71UR4RGB4
- AUC90UR4RGB4
- AUC105UR4RGB4
- AUC125UR4RHB4
- AUC140UR4RHB4
- AUC175UR4RHB4

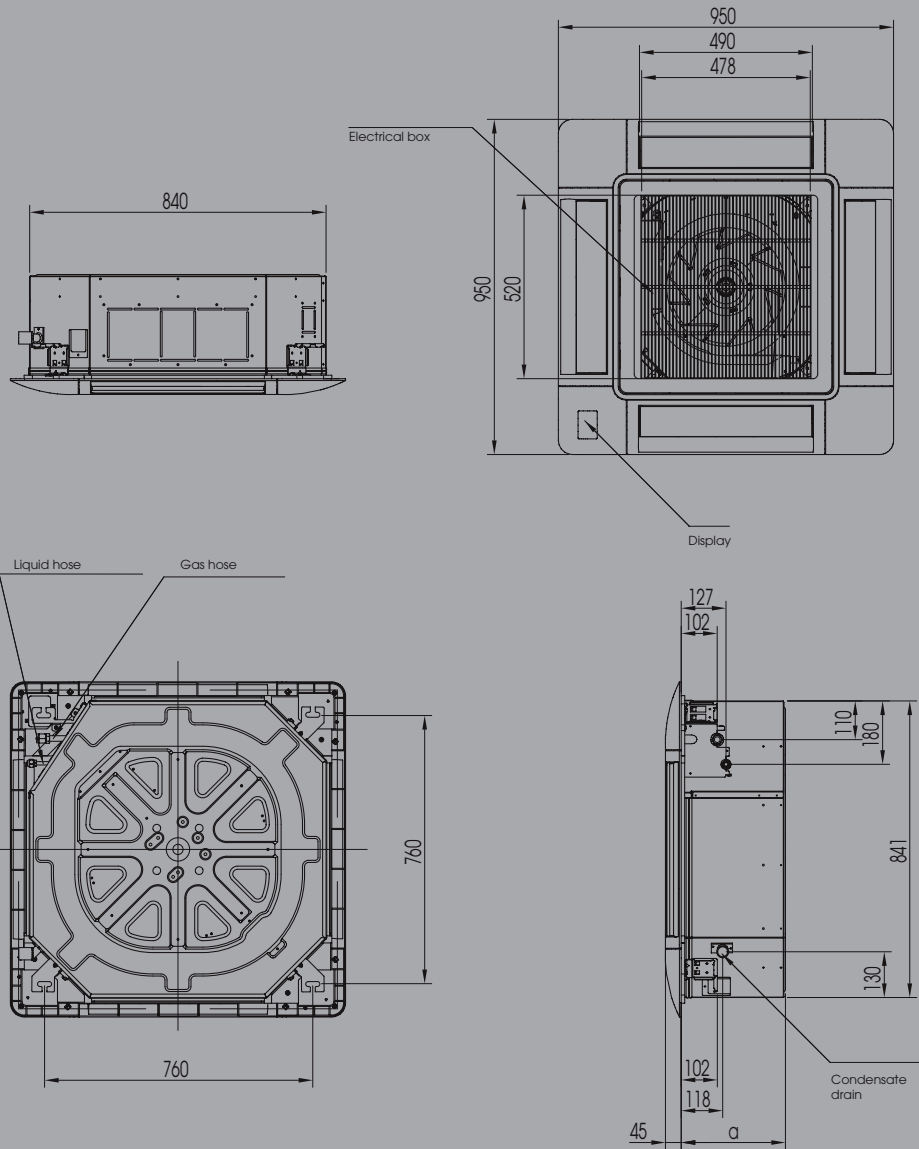

	a
AUC71UR4RGB4 / AUC90UR4RGB4 / AUC105UR4RGB4	248
AUC125U4RHB4 / AUC140UR4RHB4 / AUC175UR4RHB4	298

## Technical specifications

# Slim Duct

# FM Super R32 Inverter

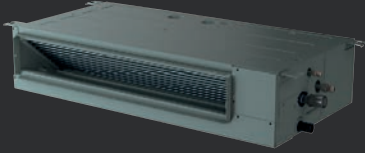

WiFi Control

ON/OFF  
FunctionRoom Card  
ControlFire Leakage  
ControlWater Level  
SwitchBuilt-in Drain  
Pump

Slim Design

Filter Clean  
Signal

Universal Unit

Indoor Model		ADT26UX4RBL4	ADT35UX4RBL4	ADT52UX4RCL4	AUD71UX4RCL4
Outdoor Model		AUW26U4RR4	AUW35U4RS4	AUW52U4RS4	AUW71U4RF4
Nominal	W	2900	3520	5300	7200
Nominal	W	3100	3800	5800	7900
SEER	W / W	6.30	6.30	6.40	6.40
SCOP	W / W	4.20	4.00	4.00	4.20
Energy Efficiency Class		A++	A++	A++	A++
Energy Efficiency Class		A+	A+	A+	A+
Power Supply	Indoor	220-240V-50/60Hz	220-240V-50/60Hz	220-240V-50/60Hz	220-240V-50/60Hz
Power Supply	Outdoor	220-240V-50/60Hz	220-240V-50/60Hz	220-240V-50/60Hz	220-240V-50/60Hz
Indoor Unit (W × H × D)	mm	910 × 190 × 447	910 × 190 × 447	1180 × 190 × 447	1180 × 190 × 447
Outdoor Unit (W × H × D)	mm	730 × 540 × 260	810 × 580 × 280	810 × 580 × 280	860 × 670 × 310
IDU Qty/per 20' / 40' / 40'HQ		160 / 352 / 396	160 / 352 / 396	128 / 264 / 297	128 / 264 / 297
ODU Qty/per 20' / 40' / 40'HQ		136 / 284 / 284	102 / 204 / 272	102 / 204 / 272	90 / 186 / 186

# Installation Drawings

- ADT26UX4RBL4
- ADT35UX4RBL4
- ADT52UX4RBL4
- AUD71UX4RCL4

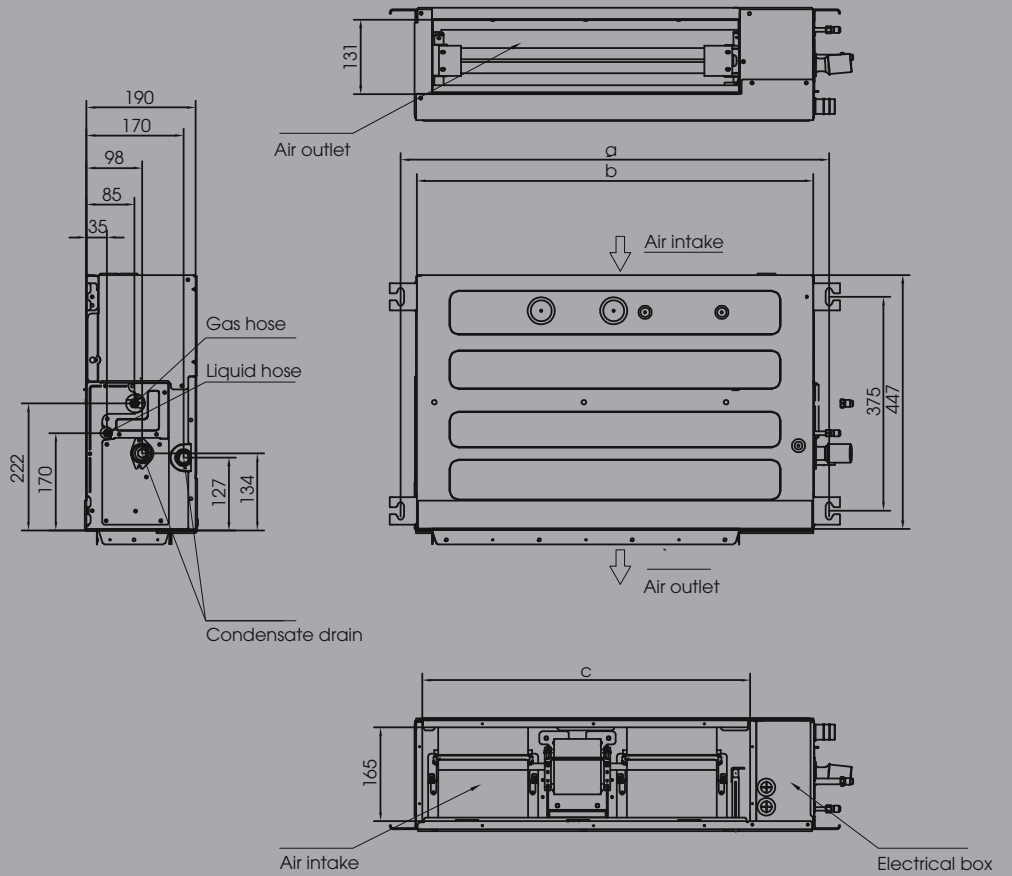

	a	b	c
ADT26 / ADT35	961	910	786
ADT52 / AUD71	1231	1180	1056

## Technical specifications

### MSP Duct

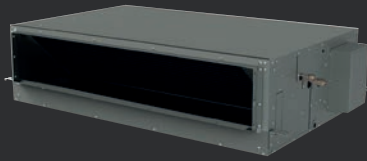

### FM Super R32 Inverter

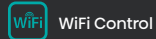

WiFi Control

ON/OFF  
FunctionRoom Card  
ControlFire Leakage  
ControlWater Level  
SwitchBuilt-in Drain  
Pump

Slim Design

Filter Clean  
Signal

I Feel

Indoor Model		AUD71UX4RDH4	AUD90UX4RDH5	AUD105UX4RDH5	AUD125UX4RHH5
Outdoor Model		AUW71U4RF4	AUW90U4RF4	AUW105U4RA4	AUW125U6RT4
Nominal	W	7300	8800	10500	12500
Nominal	W	8000	9000	11500	13400
SEER	W / W	7.00	6.20	6.10	—
SCOP	W / W	4.05	4.00	4.00	—
Energy Efficiency Class		A++	A++	A++	—
Energy Efficiency Class		A+	A+	A+	—
Power Supply	Indoor	220-240V~50/60Hz	220-240V~50/60Hz	220-240V~50/60Hz	220-240V~ 50/ 60Hz
Power Supply	Outdoor	220-240V~50/60Hz	220-240V~50/60Hz	220-240V~50/60Hz	380-415V 3N~ 50/60Hz
Indoor Unit (W × H × D)	mm	1140 × 268 × 720	1140 × 268 × 720	1140 × 268 × 720	1300 × 350 × 800
Outdoor Unit (W × H × D)	mm	860 × 670 × 310	860 × 670 × 310	950 × 840 × 340	950 × 1050 × 340
IDU Qty/per 20' / 40' / 40'HQ		60 / 126 / 147	60 / 126 / 147	60 / 126 / 147	35 / 75 / 90
ODU Qty/per 20' / 40' / 40'HQ		90 / 186 / 186	90 / 186 / 186	52 / 106 / 106	26 / 53 / 106

Indoor Model		AUD125UX4RHH5	AUD140UX4RHH5	AUD140UX4RHH5	AUD175UX4RHH5
Outdoor Model		AUW125U4RT5	AUW140U6RP4	AUW140U4RP5	AUW175U6RP4
Nominal	W	12500	14400	14100	17500
Nominal	W	13400	17300	17100	18500
SEER	W / W	—	—	—	—
SCOP	W / W	—	—	—	—
Energy Efficiency Class		—	—	—	—
Energy Efficiency Class		—	—	—	—
Power Supply	Indoor	220-240V~50/60Hz	220-240V~ 50/ 60Hz	220-240V~50/60Hz	220-240V~ 50/ 60Hz
Power Supply	Outdoor	220-240V~50/60Hz	380-415V 3N~ 50/60Hz	220-240V~50/60Hz	380-415V 3N~ 50/60Hz
Indoor Unit (W × H × D)	mm	1300x350x800	1300 × 350 × 800	1300 × 350 × 800	1300 × 350 × 800
Outdoor Unit (W × H × D)	mm	950 × 1050 × 340	950 × 1386 × 340	950 × 1386 × 340	950 × 1386 × 340
IDU Qty/per 20' / 40' / 40'HQ		35 / 75 / 90	35 / 75 / 90	35 / 75 / 90	35 / 75 / 90
ODU Qty/per 20' / 40' / 40'HQ		26 / 53 / 106	26 / 53 / 53	26 / 53 / 53	26 / 53 / 53



# Installation Drawings

AUD90UX4RDH5  
AUD105UX4RDH5

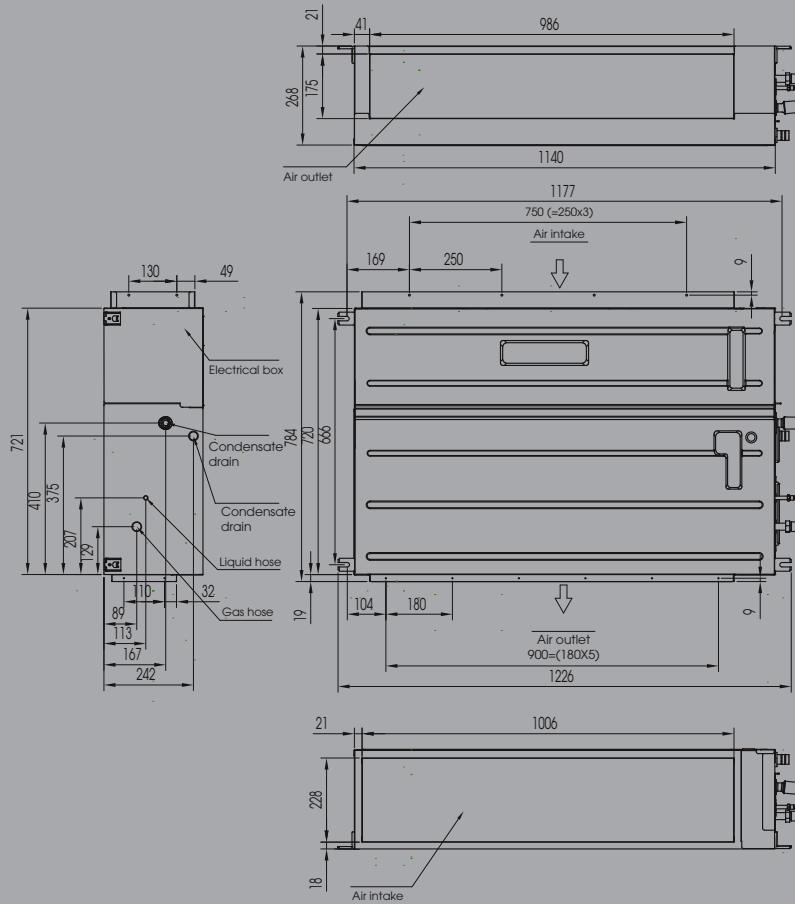

AUD125UX4RHH5  
AUD140UX4RHH5  
AUD175UX4RHH5

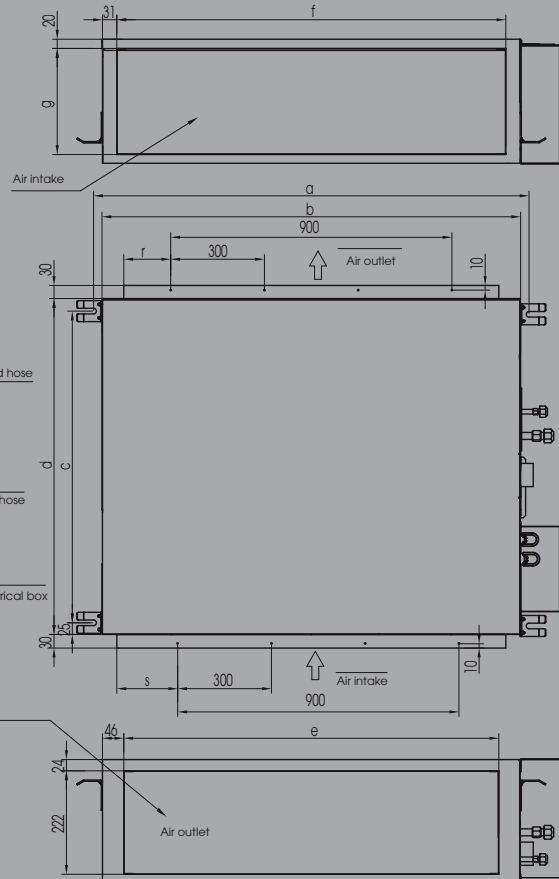

<b>a</b>	<b>b</b>	<b>c</b>
1334	1300	756
<b>d</b>	<b>e</b>	<b>f</b>
800	1205	1235
<b>g</b>	<b>h</b>	<b>i</b>
308	237	312
<b>j</b>	<b>k</b>	<b>l</b>
375	400	204
<b>m</b>	<b>n</b>	<b>o</b>
186	242	350
<b>p</b>	<b>q</b>	<b>r</b>
3	900	153
<b>s</b>	<b>t</b>	<b>u</b>
168	90	140

## Technical specifications

### Ceiling & Floor



### FM Super R32 Inverter

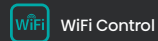

WiFi Control

ON/OFF  
FunctionRoom Card  
ControlFire Leakage  
Control

4D Airflow



High Ceiling



Slim Design

Silver  
Ion Filter

I Feel

Indoor Model		AVT52UR4RA4	AUV71UR4RA4	AUV90UR4RB4	AUV105UR4RB4	AUV125UR4RC4
Outdoor Model		AUW52U4RS4	AUW71U4RF4	AUW90U4RF4	AUW105U4RA4	AUW125U6RT4
Nominal	W	5280	6900	8800	10000	12300
Nominal	W	5600	7800	9000	11300	13500
SEER	W / W	6.30	6.10	6.10	6.10	—
SCOP	W / W	4.40	4.20	4.10	4.00	—
Energy Efficiency Class		A++	A++	A++	A++	—
Energy Efficiency Class		A+	A+	A+	A+	—
Power Supply	Indoor	220-240V~50/60Hz	220-240V~50/60Hz	220-240V~50/60Hz	220-240V~50/60Hz	220-240V~ 50/ 60Hz
Power Supply	Outdoor	220-240V~ 50/ 60Hz	220-240V~50/60Hz	220-240V~50/60Hz	220-240V~50/60Hz	380-415V 3N~ 50/60Hz
Indoor Unit (W × H × D)	mm	990 × 680 × 230	990 × 680 × 230	1285 × 680 × 230	1285 × 680 × 230	1580 × 680 × 230
Outdoor Unit (W × H × D)	mm	810 × 580 × 280	860 × 670 × 310	860 × 670 × 310	950 × 840 × 340	950 × 1050 × 340
IDU Qty/per 20' / 40' / 40'HQ		84 / 168 / 196	84 / 168 / 196	66 / 132 / 154	66 / 132 / 154	42 / 84 / 98
ODU Qty/per 20' / 40' / 40'HQ		102 / 204 / 272	90 / 186 / 186	90 / 186 / 186	52 / 106 / 106	26 / 53 / 106

Indoor Model		AUV125UR4RC4	AUV140UR4RC4	AUV140UR4RC4	AUV175UR4RC4
Outdoor Model		AUW125U4RT5	AUW140U6RP4	AUW140U4RP5	AUW175U6RP4
Nominal	W	12700	14300	14000	17000
Nominal	W	13500	16700	16500	18000
SEER	W / W	—	—	—	—
SCOP	W / W	—	—	—	—
Energy Efficiency Class		—	—	—	—
Energy Efficiency Class		—	—	—	—
Power Supply	Indoor	220-240V~50/60Hz	220-240V~ 50/ 60Hz	220-240V~50/60Hz	220-240V~ 50/ 60Hz
Power Supply	Outdoor	220-240V~50/60Hz	380-415V 3N~ 50/60Hz	220-240V~50/60Hz	380-415V 3N~ 50/60Hz
Indoor Unit (W × H × D)	mm	1580x680x230	1580 × 680 × 230	1580 × 680 × 230	1580 × 680 × 230
Outdoor Unit (W × H × D)	mm	950 × 1050 × 340	950 × 1386 × 340	950 × 1386 × 340	950 × 1386 × 340
IDU Qty/per 20' / 40' / 40'HQ		42 / 84 / 98	42 / 84 / 98	42 / 84 / 98	42 / 84 / 98
ODU Qty/per 20' / 40' / 40'HQ		26 / 53 / 106	26 / 53 / 53	26 / 53 / 53	26 / 53 / 53

# Installation Drawings

AVT52UR4RA4  
 AUV71UR4RA4  
 AUV90UR4RB4  
 AUV105UR4RB4  
 AUV125UR4RC4  
 AUV140UR4RC4  
 AUV175UR4RC4

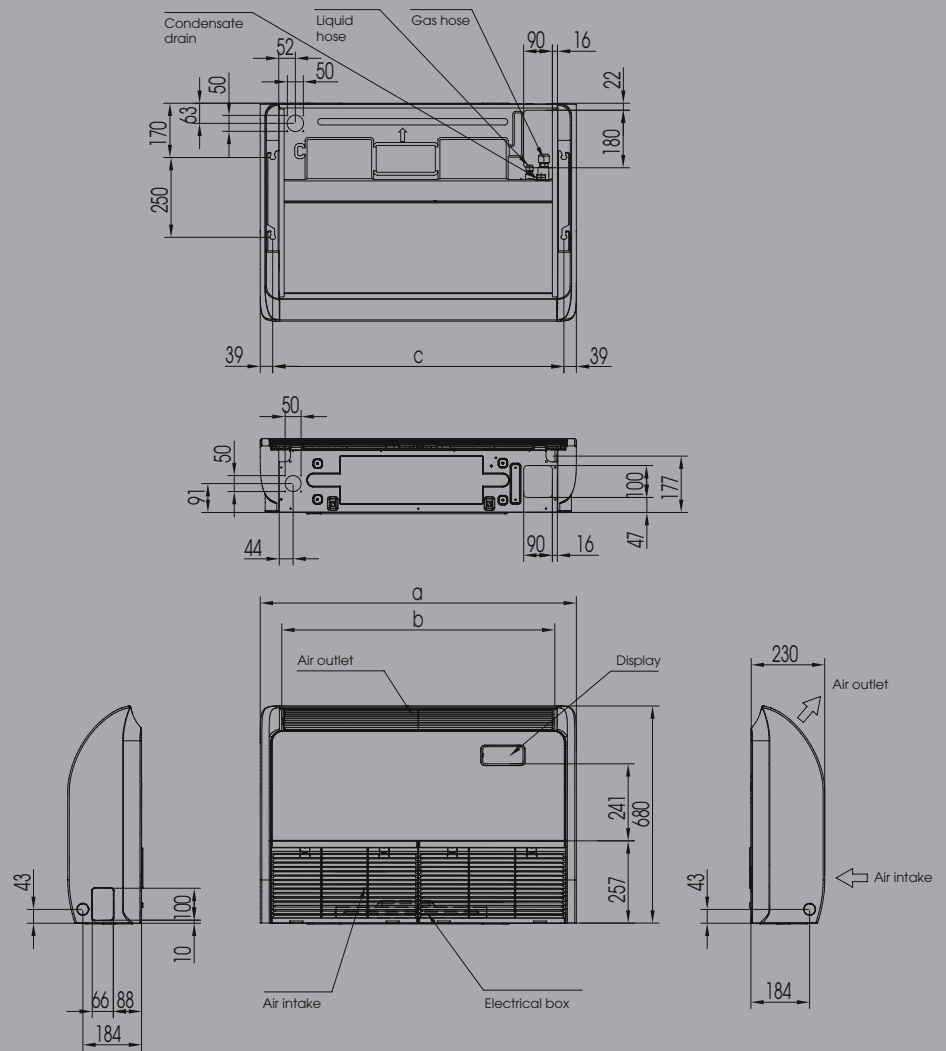

	a	b	c
AVT52UR4RA4 / AUV71UR4RA4	990	855	912
AUV90UR4RB4 / AUV105UR4RB4	1285	1150	1207
AUV125UR4RC4 / AUV140UR4RC4 / AUV175UR4RC4	1580	1445	1502

## Technical specifications

# Console

## FM Super R32 Inverter



WiFi Control

ON/OFF  
FunctionRoom Card  
ControlFire Leakage  
ControlVertical  
Auto SwingWired  
Controller

Slim Design



Universal Unit



I Feel

Indoor Model		AKT26UR4RK4	AKT35UR4RK4	AKT52UR4RK4
Outdoor Model		AUW26U4RR4	AUW35U4RS4	AUW52U4RS4
Nominal	W	2950	3520	5000
Nominal	W	3050	3800	5100
SEER	W / W	6.50	6.50	6.50
SCOP	W / W	4.20	4.10	4.10
Energy Efficiency Class		A++	A++	A++
Energy Efficiency Class		A+	A+	A+
Power Supply	Indoor	220-240V-50/60Hz	220-240V-50/60Hz	220-240V-50/60Hz
Power Supply	Outdoor	220-240V-50/60Hz	220-240V-50/60Hz	220-240V-50/60Hz
Indoor Unit (W × H × D)	mm	700 × 630 × 220	700 × 630 × 220	700 × 630 × 220
Outdoor Unit (W × H × D)	mm	730 × 540 × 260	810 × 580 × 280	810 × 580 × 280
IDU Qty/per 20' / 40' / 40'HQ		154 / 308 / 308	154 / 308 / 308	154 / 308 / 308
ODU Qty/per 20' / 40' / 40'HQ		136 / 284 / 284	102 / 204 / 272	102 / 204 / 272

# Installation Drawings

AKT26UR4RK4  
 AKT35UR4RK4  
 AKT52UR4RK4

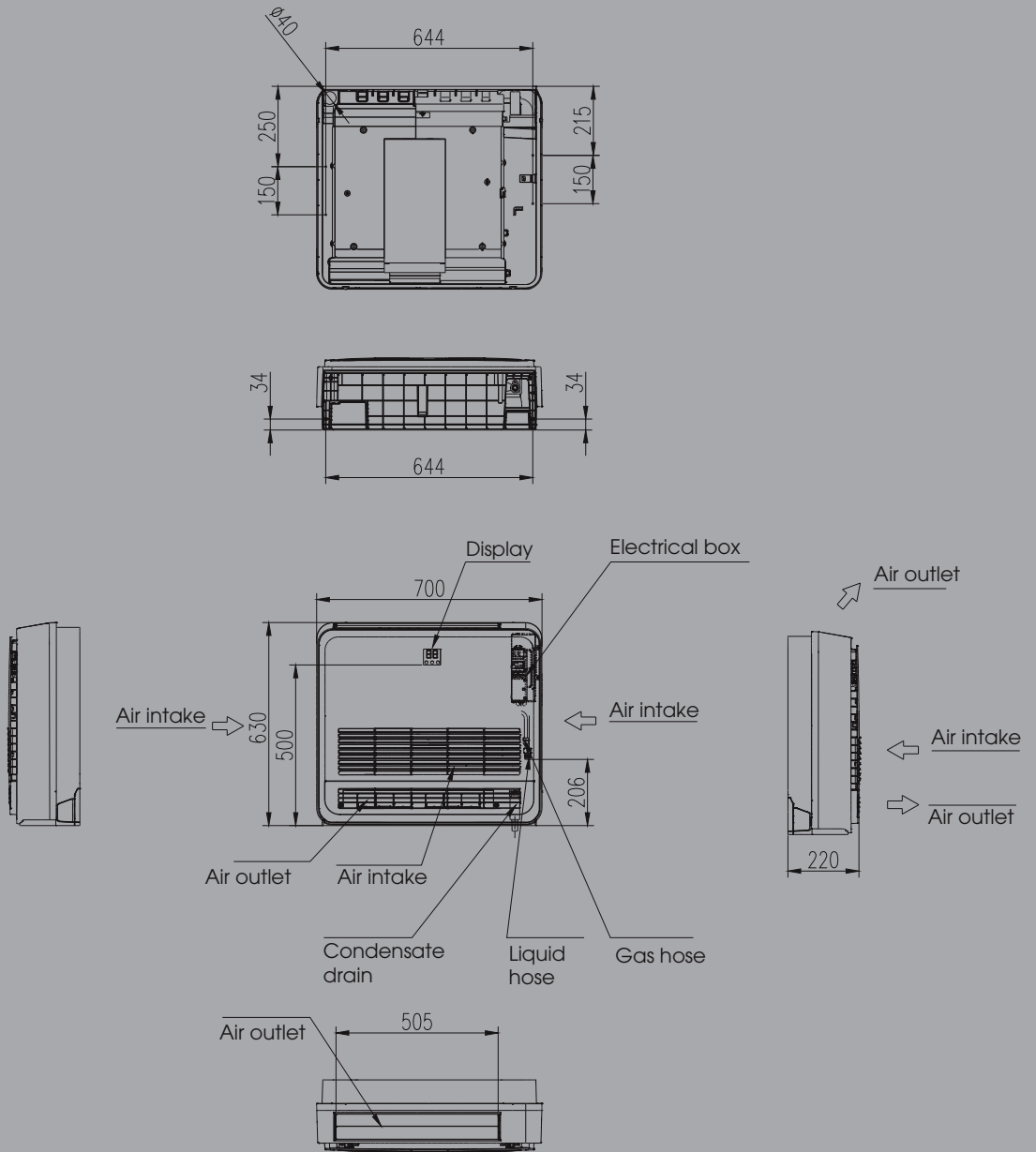

## Technical specifications

# Floor Standing

ERP R32



WiFi Easy



ON/OFF Function

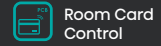

Room Card Control

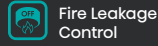

Fire Leakage Control



4D Airflow



Sleep Mode



Wired Controller



I Feel

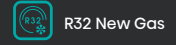

R32 New Gas

Indoor Model	AUF140UR4RMPA	
Outdoor Model	AUW140U6RT	
Nominal	W	12300
Nominal	W	14000
SEER	W / W	—
SCOP	W / W	—
Energy Efficiency Class	—	
Energy Efficiency Class	—	
Power Supply	Indoor	220-240V~50/60Hz
Power Supply	Outdoor	380-415V 3N~ 50/60Hz
Indoor Unit (W × H × D)	mm	580 × 1870 × 380
Outdoor Unit (W × H × D)	mm	950 × 1050 × 340
IDU Qty/per 20' / 40' / 40'HQ	32 / 68 / 85	
ODU Qty/per 20' / 40' / 40'HQ	26 / 53 / 106	

# Installation Drawings

AUF140UR4RMPA

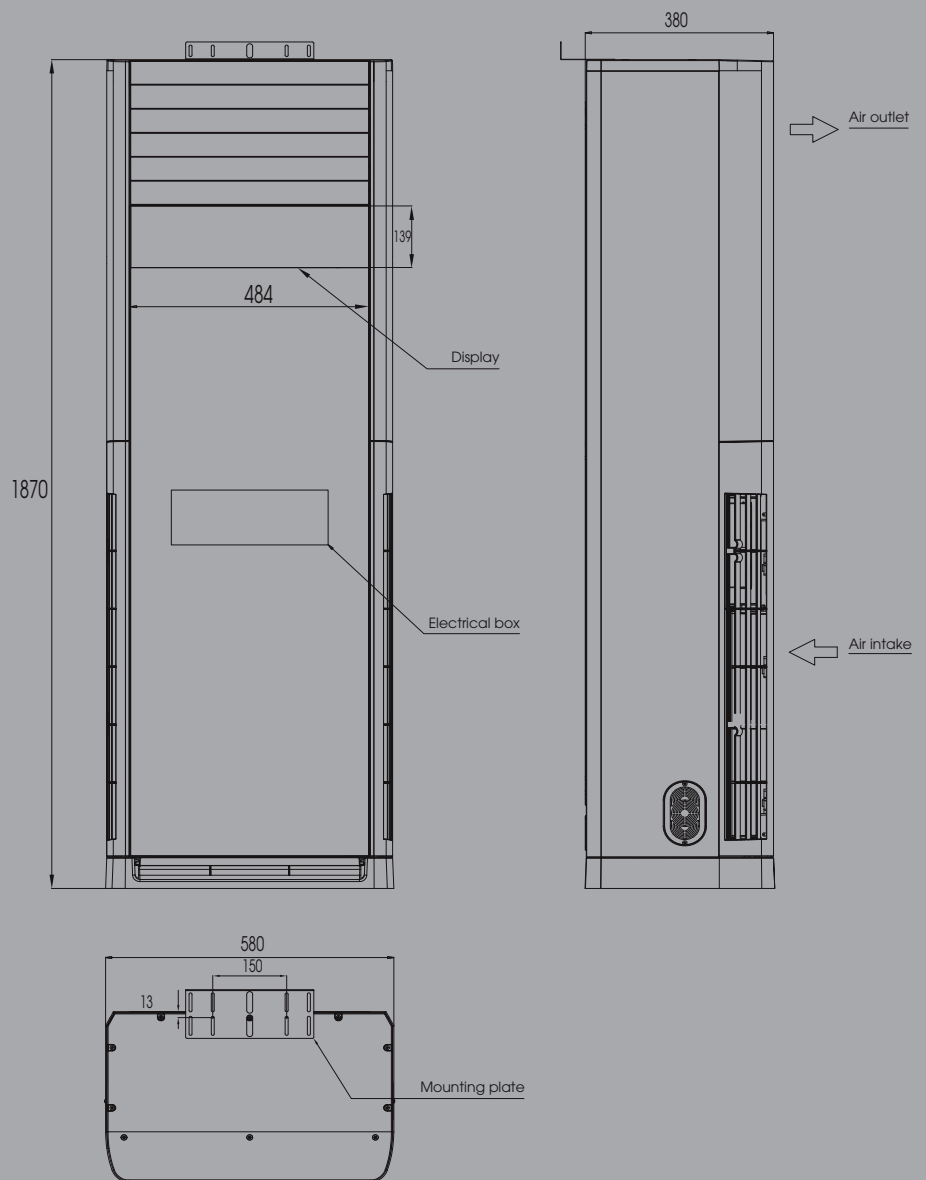

## Technical specifications

# Floor Standing

ERP R32



Fresh air



AI Smart



I Feel



HI-NANO



Four Sleep modes



TMS



Indoor Self clean



Anti-Virus fin

Indoor Model		AUF71UR4RXB
Outdoor Model		AUW71U4RJ
Nominal	W	7000
Nominal	W	7500
SEER	W / W	7.00
SCOP	W / W	4.30
Energy Efficiency Class		A++/New ERP B
Energy Efficiency Class		A+/New ERP B
Power Supply	Indoor	220-240V/1/50&60
Power Supply	Outdoor	220-240V/1/50&60
Indoor Unit (W × H × D)	mm	372×1818×372
Outdoor Unit (W × H × D)	mm	860×670×310
IDU Qty/per 20' / 40' / 40'HQ		44/92/115
ODU Qty/per 20' / 40' / 40'HQ		90/186/186



# Installation Drawings

AUF71UR4RXB

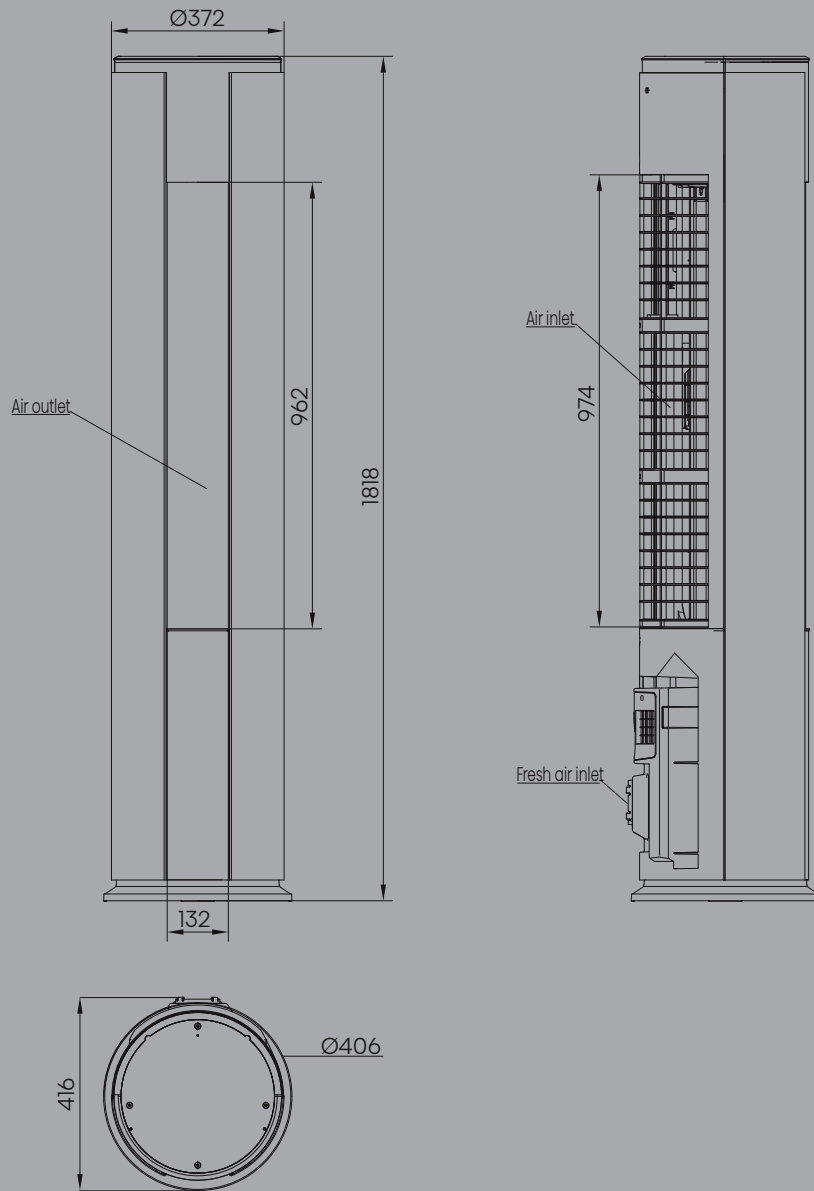





**05** | CONTROL  
SYSTEM &  
ACCESSORIES



### YXE-C01U1(E)

Common wired controller with most functions.

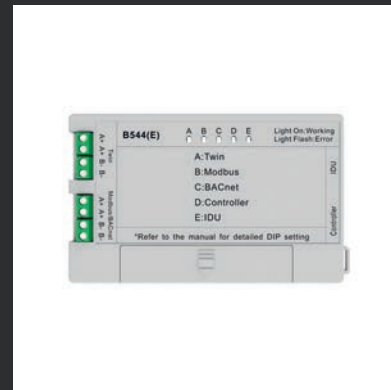

### B544(E)

Communicating box for Twin and central control systems with support for Modbus and BACnet communication protocols.



### YJE-C01T(E)

Central controller, controlling 16 IDUs at most.



### Pump P-16

External pump, used for AC without internal pump.

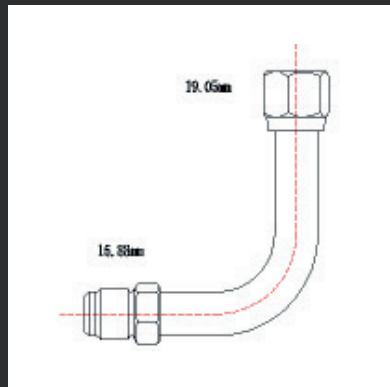

### Pipe Adapter L

- HS2019577, from 19.05mm to 15.88mm



### Pump P-12

Semi-external pump, used for AC without internal pump.

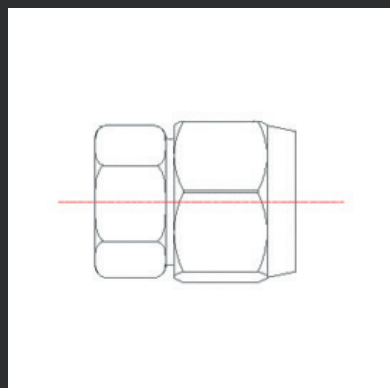

### Adapter

- HS2014749, from 9.52mm to 15.88mm

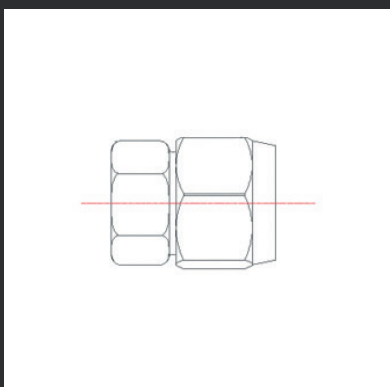

### Adapter

- HS1493010, from 9.52mm to 12.7mm

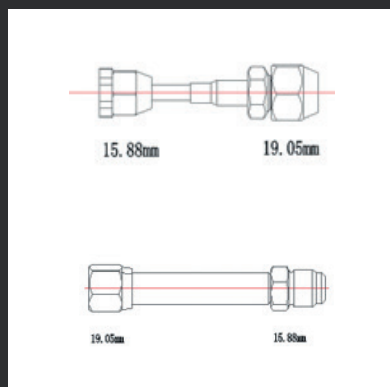

### Pipe Adapter



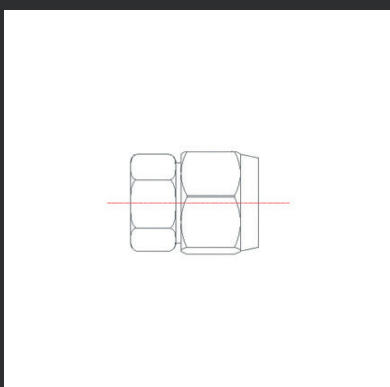

- HS1931361, from 15.88mm to 19.05mm
- HS1894684, from 19.05mm to 15.88mm

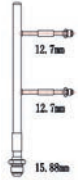

### Adapter

- HS2014748, from 6.35mm to 9.52mm

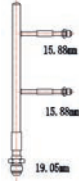
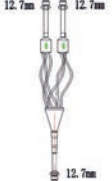
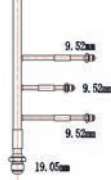
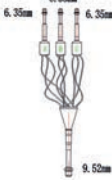
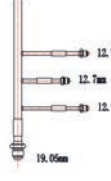
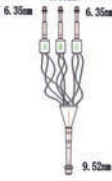
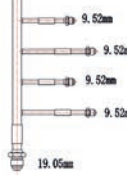
# Branch Tubes

Split	Branch Tube	Liquid Tube	Gas Tube		
Twin	FQ-2S3110(E)	5/8(x1), 3/8(x2)	3/8(x1), 1/4(x2)		
Twin	FQ-2S4311(E)	3/4(x1), 5/8(x2)	3/8(x1), 3/8(x2)		
Triple	FQ-3S4110(E)	3/4(x1), 3/8(x3)	3/8(x1), 1/4(x3)		
Triple	FQ-3S4210(E)	3/4(x1), 1/2(x3)	3/8(x1), 1/4(x3)		
Quadruple	FQ-4S4110(E)	3/4(x1), 3/8(x4)	3/8(x1), 1/4(x4)		

Note: 1/4: 6.35mm  
 3/8: 9.52mm  
 1/2: 12.7mm  
 5/8: 15.88mm  
 3/4: 19.05mm

	YXE-C01U1(E)	YJE-C01T(E)
<b>Main Function</b>		
Max Connectable Indoor	1	16
Unit Modes	•	•
Temperature Setting	•	•
Timer	•	•
Sleep	•	•
Weekly Schedule	•	•
Error Code Display	•	•
One Error Shielded	•	•
Check	•	•
Wireless Remote Receive	•	×
Wireless Remote Receive Forbid	•	×
Touch Lock/Bottom Lock	•	•
Operation Monitor	•	•
Filter Cleaning Remind	•	•
Filter Cleaning Timing	•	•
°C/°F	•	•
Temperature Display switching	•	•
Clock	•	•
Mode Lock	•	•
Temperature Range Limit	•	•
Temperature Range Limit Forbid	•	•
Central & Group Controlled	×	×
Central & Group Controller	×	•
Address Setting (For Being Controlled)	•	•
Simplified Central Controller	×	×
I Feel	•	•
Temperature Compensation	•	•
Temperature Compensation Forbid	•	•
High Ceiling Function	•	•
Duct Static Pressure Setting	•	•
On-off Setting	•	•
Auto Restart	•	•
Alarm On or Off	•	•
Dimer	•	•
Mute	•	•
Powerful	•	•
Up and Down Swing	•	•
Left and Right Swing	•	•
<b>Features</b>		
LCD Screen	•	•
Compact 86×86×15	×	×
Big 120×120×20	•	•
<b>Power Supply</b>		
DC 12-17V	•	×
AC 175-264V	×	•
Distance to the Indoor Unit	40m	40m
Built-in Backup Power	×	×
<b>Communicate</b>		
BACnet	×	•

# BEMS\*

To meet the diverse needs of customers, Hisense can offer a variety of control options for our systems, such as group control, centralized control, and building energy management system (BEMS) options. For detailed information, please contact Hisense professional after-sale service people.

\*BEMS: Building Energy Management System

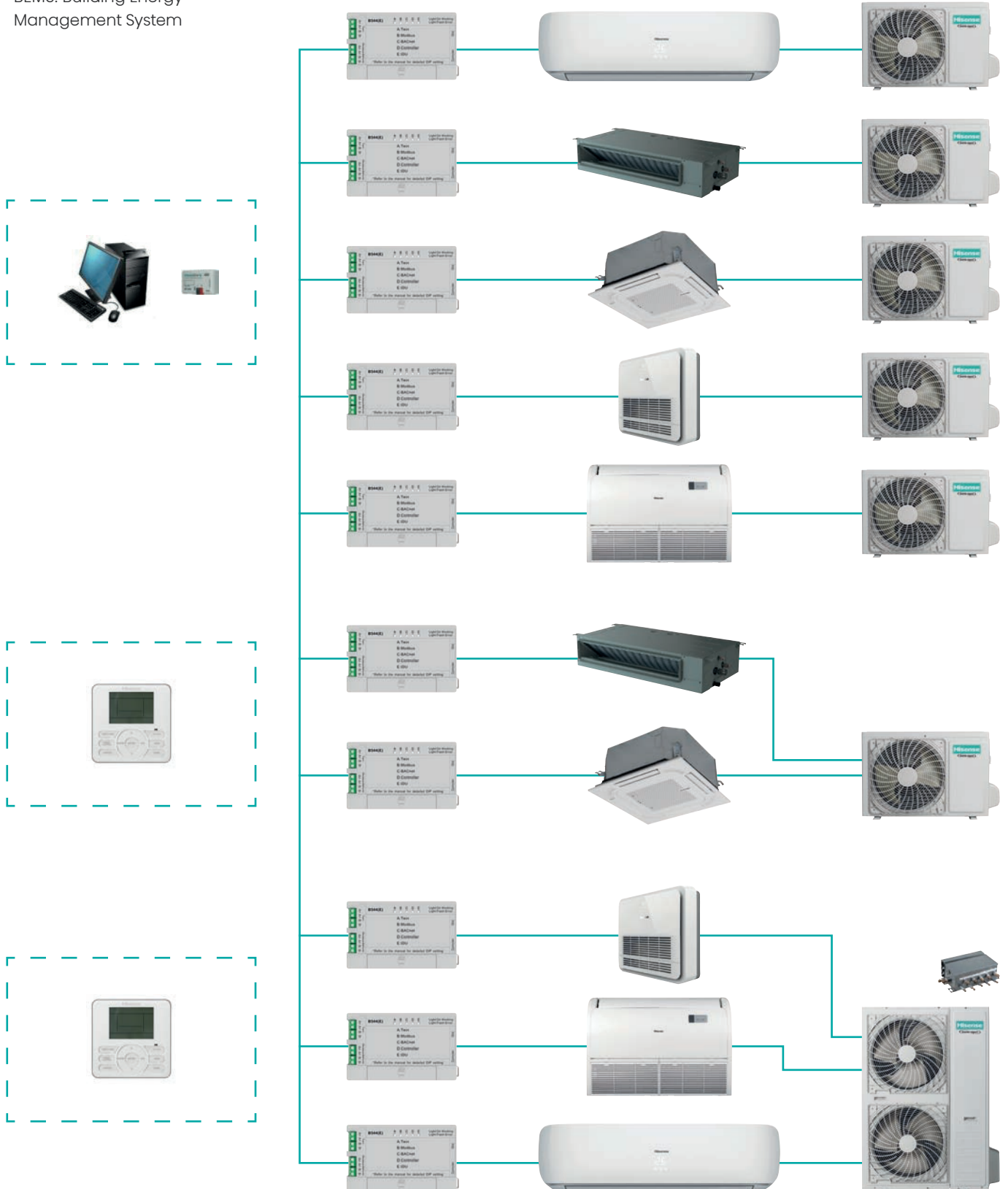

Note:

The max quantity of indoor units is 16. • The max quantity of centralized controller is 2. • The quantity of upper computer is not limited.





life reimagined







---

Hisense International Co., Ltd.

Add: F22, Hisense Tower, 17 Donghaixi Road  
Qingdao, China 266071  
Tel: +86-532-83878888  
Fax: +86-532-83866770  
E-mail: [marketing@hisense.com](mailto:marketing@hisense.com)  
Website: <http://global.hisense.com>

Add: 08 Ronggang Road, Ronggui, Shunde, Foshan, Guangdong, China.  
Fax: +86-757-28361060  
E-mail: [marketing@hisense.com](mailto:marketing@hisense.com)  
Website: <http://global.hisense.com>

Note: Product design and specification subject to change without prior notice.

© 2022 Hisense Corporation. All rights reserved. Hisense and the Hisense logo are trademarks or registered trademarks of Hisense Group in China and/or other countries. All rights reserved. The Hisense Smart TV logo, Ultra HD High Definition logo, SMR logo and life reimagined logo are trademarks or registered trademarks of Hisense Electric Co., Ltd. in China and/or other countries. All rights reserved. All other company names, brand names, trademarks and logos are the property of their respective owners. All rights reserved.